

44305 **Bahnhof "Zeil" Z**

Station "Zeil" Z - Gare "Zeil" Z

Estación ferroviaria "Zeil" Z - Station "Zeil" Z



Hinweis:

Durch die liegende Lagerung im Bausatz kann sich der Klebstoff in der Tube nach unten abgesetzt haben, sodass beim ersten Drücken Wasser aus der Tube entweicht. Vor dem ersten Einsatz des Klebers daher bitte die Tube kurz durchkneten und zunächst auf einem Blatt Papier probieren. Für die Verklebung von kleinen Teilen empfehlen wir Ihnen den einzeln erhältlichen NOCH Laser-Cut Kleber (Art.-Nr. 61104) mit der besonders feinen Dosierspitze.

Note:

Owing to the horizontal storage of the glue in the package it is possible that some water will come out when first pressing the tube. Before first use, please knead the tube briefly and make a test on a sheet of paper. For fixing small parts we recommend the NOCH Laser-Cut Adhesive (ref. 61104) with a very fine dosing tip.

Indication:

A cause du stockage horizontal, la colle dans le tube peut se déposer vers le bas de sorte que de l'eau s'échappe du tube en le pressant pour la première fois. Avant le premier usage, il faut donc pétrir le tube et faire un test sur une feuille de papier. Pour le collage des petits éléments, il convient d'utiliser de la colle Laser-Cut NOCH (réf. 61104) avec la fine pointe de dosage.

Nota:

Debido al almacenamiento horizontal del kit, es posible que el pegamento se haya asentado en la base, y que al ejercer la primera presión sobre el tubo salga agua. Por ello antes de usar el pegamento por primera vez, amase el tubo brevemente y pruébalo primero sobre un papel. Para la encolado de piezas pequeñas, recomendamos el pegamento especial para cartón cortado por láser NOCH disponible individualmente (Ref. 61104) con la boquilla dosificadora especialmente fina.

Aanwijzing:

Door het liggend opslaan van de bouwdoos kan de lijm in de tube naar onderen gelopen zijn, waardoor bij de eerste keer drukken water uit de tube komt. Voor gebruik van de lijm daarom eerst de tube kort kneden en dan op een stukje papier uitproberen. Voor het lijmen van kleine onderdelen adviseren wij de los verkrijgbare speciale NOCH laser-cut lijm (art. nr. 61104) met de zeer fijne doseerpunt.

*Dieses Gebäude besteht aus sehr vielen Einzelteilen.
Bitte trennen Sie die Teile erst dann aus der Platte,
wenn der jeweilige Arbeitsschritt erreicht ist. Eine
handschriftliche Nummerierung am Plattenrand kann
sehr hilfreich sein.*

*This building consists of a large number of single
parts.*

*Please do not rip the parts out of the plate before you
need them for the next assembly step.
It can be very useful to number the plates on the
edges.*

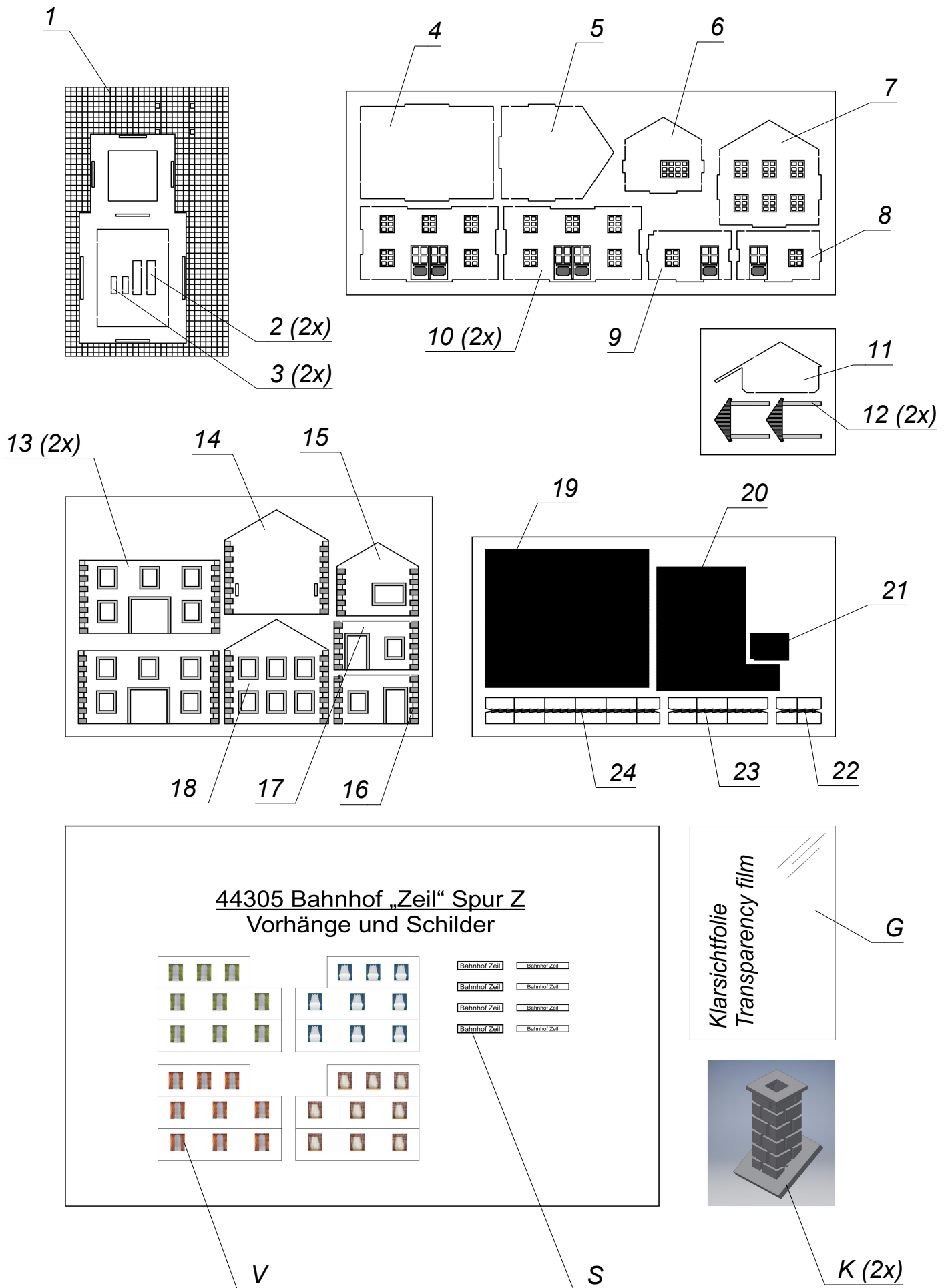

1. 2x

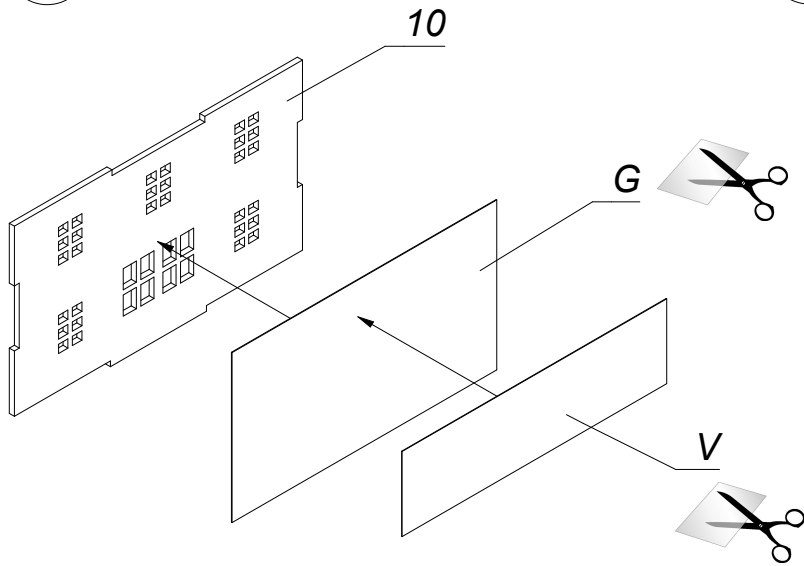

2.

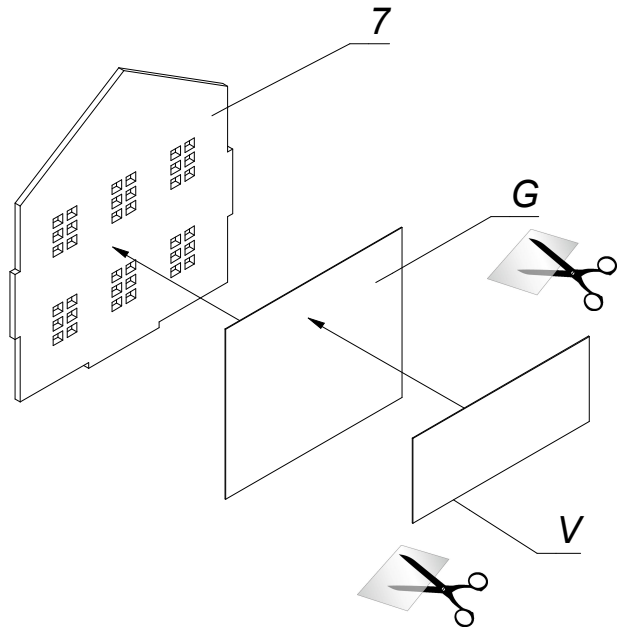

3.

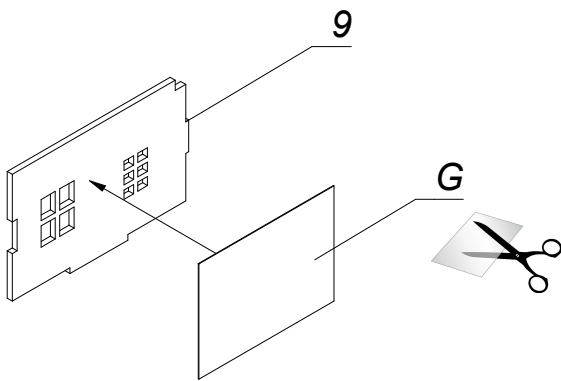

4.

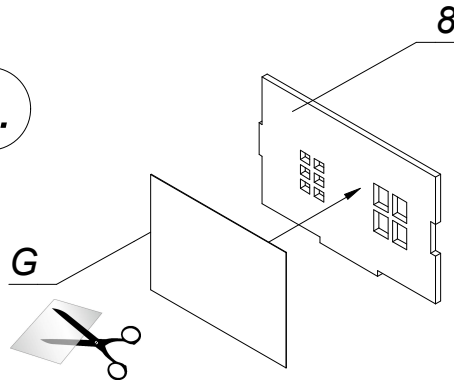

Dieses Teil austrennen.

Rip out this part.

5.

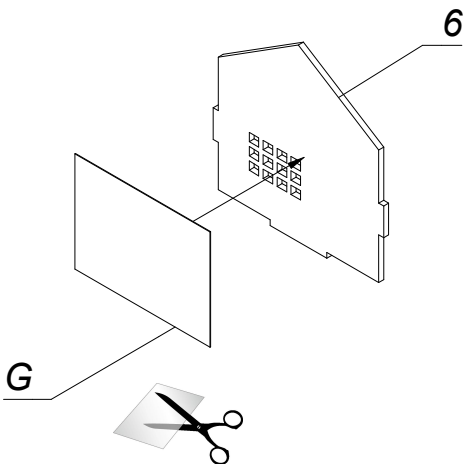

6.

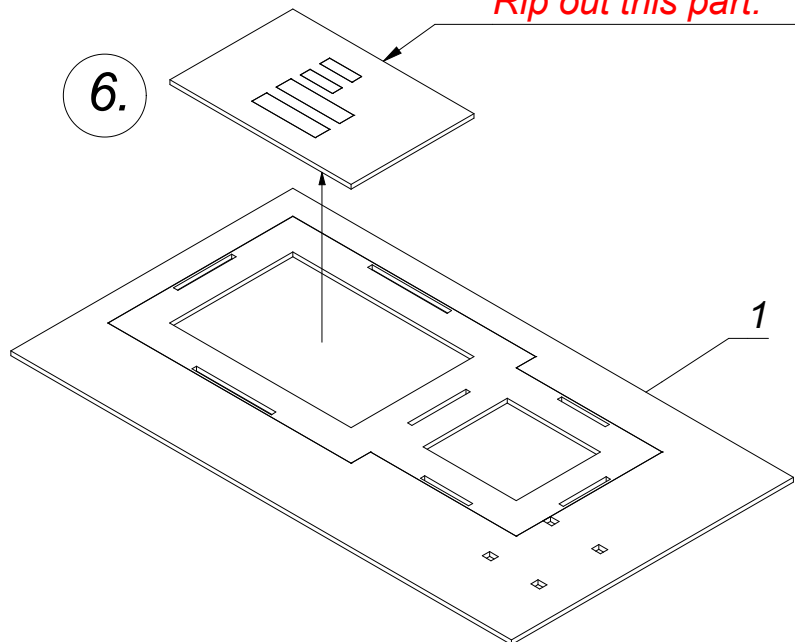

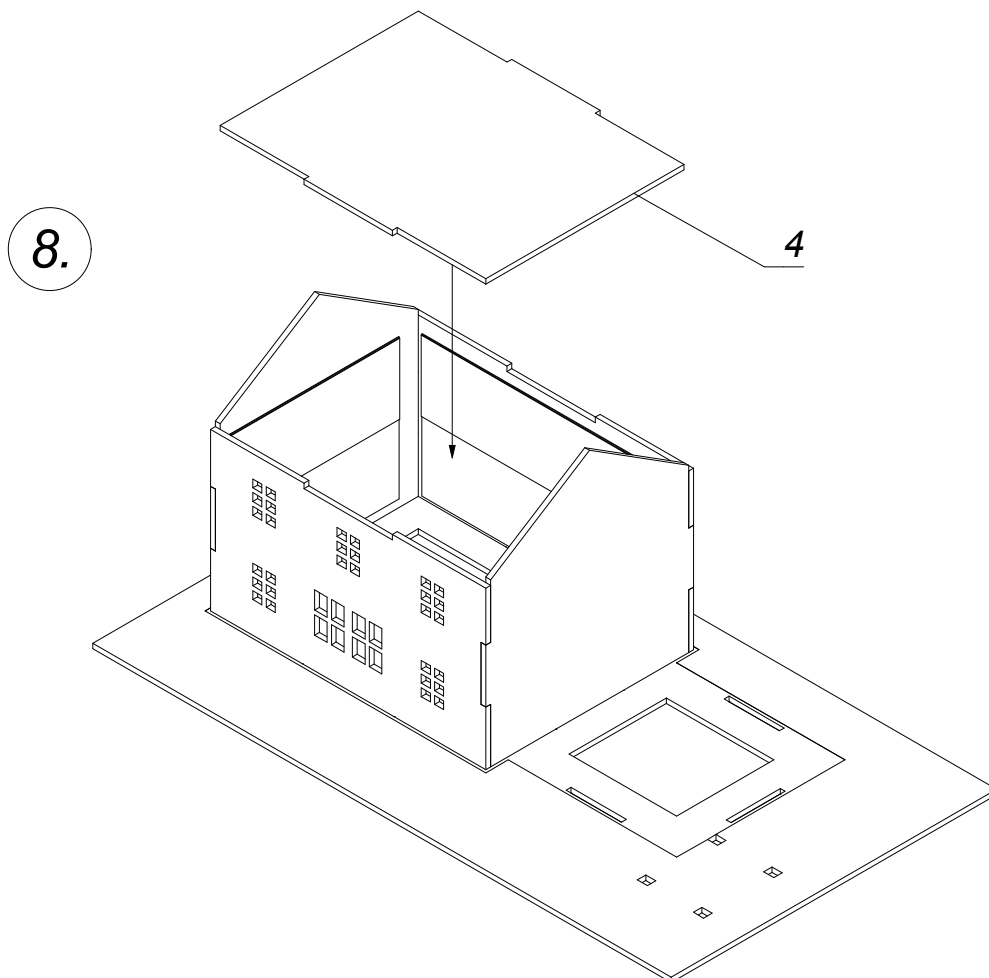
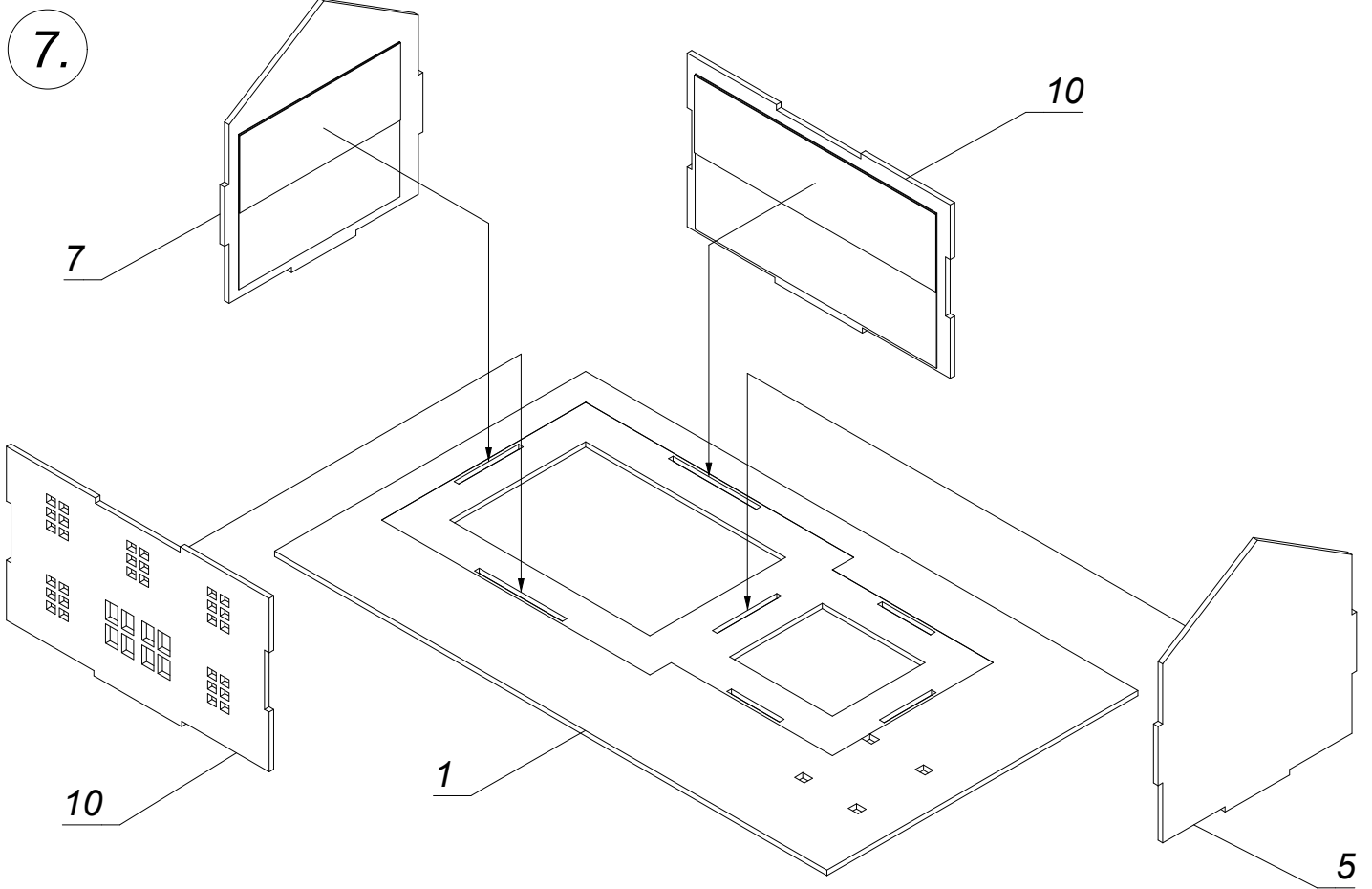

9.

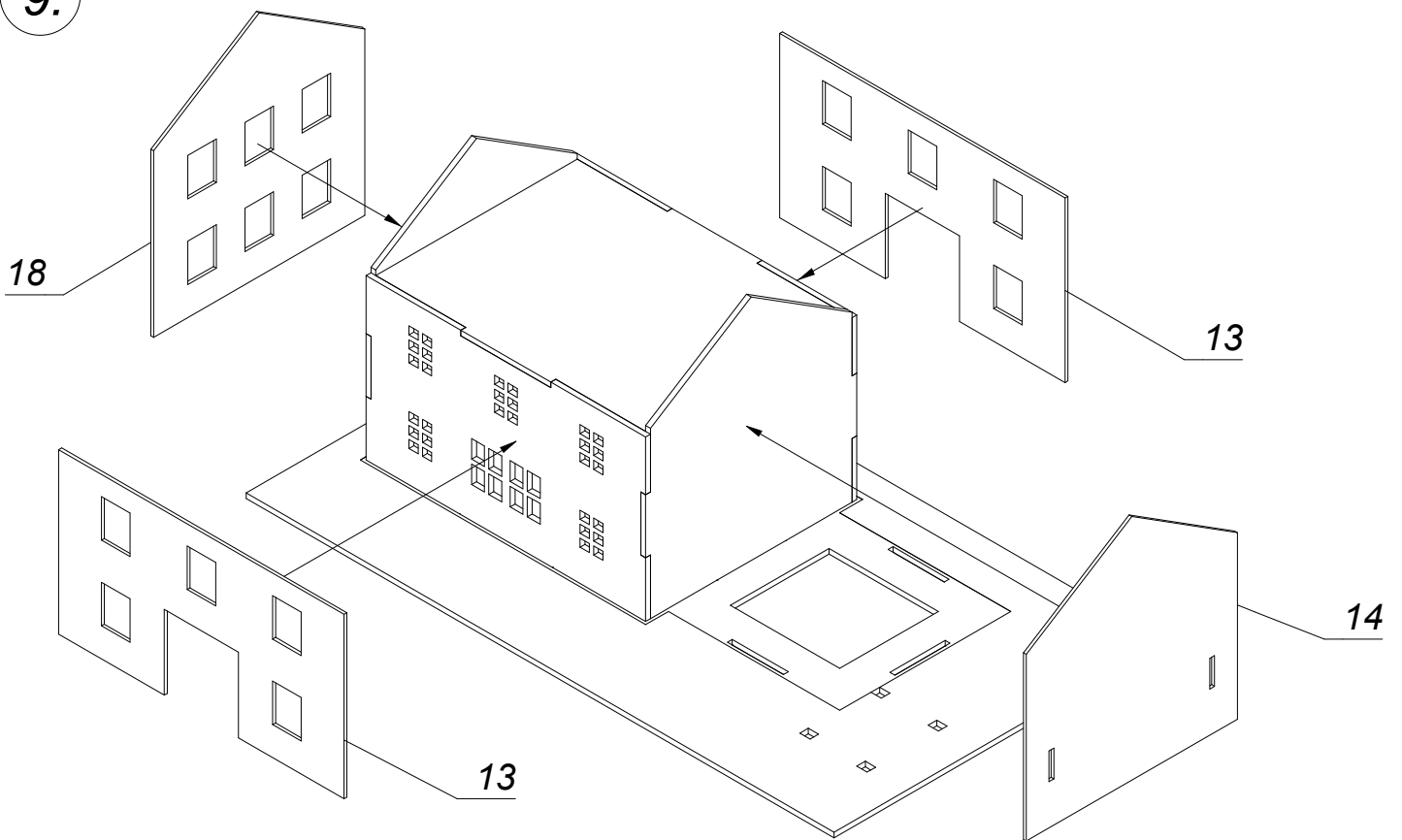

10.

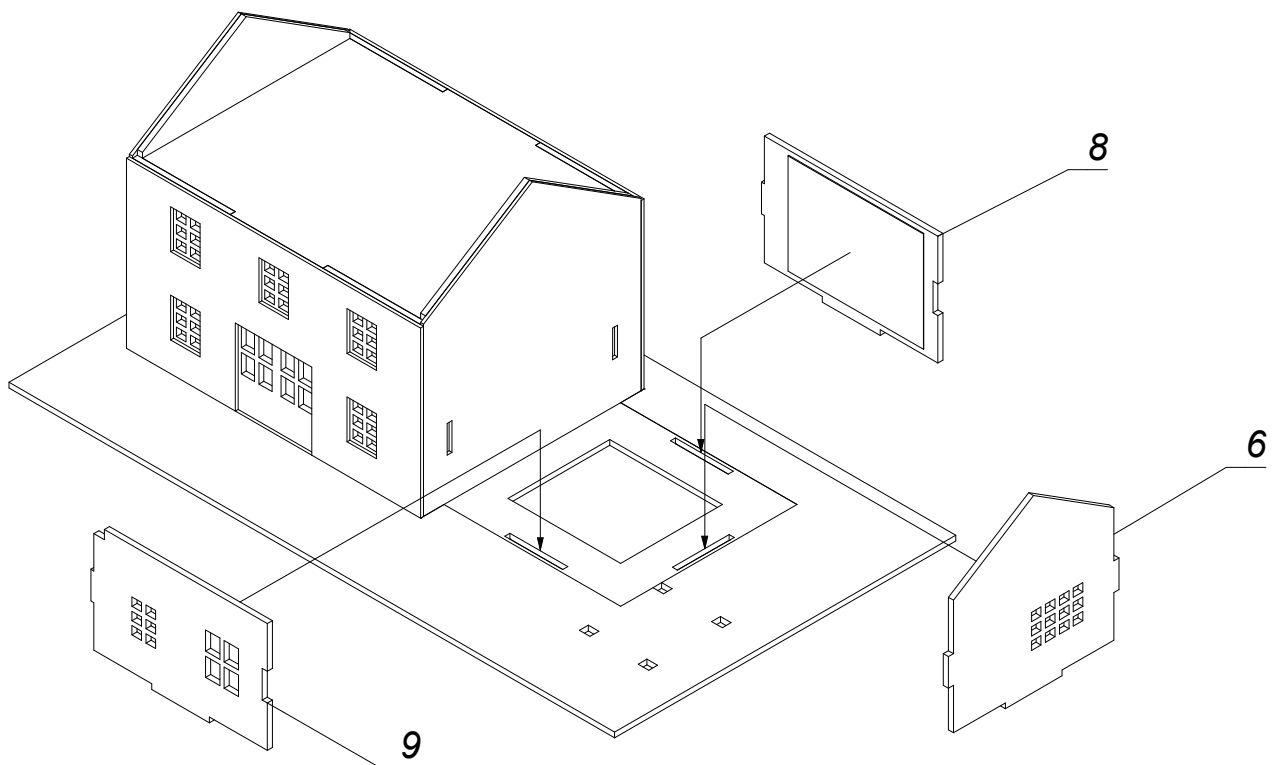

11.

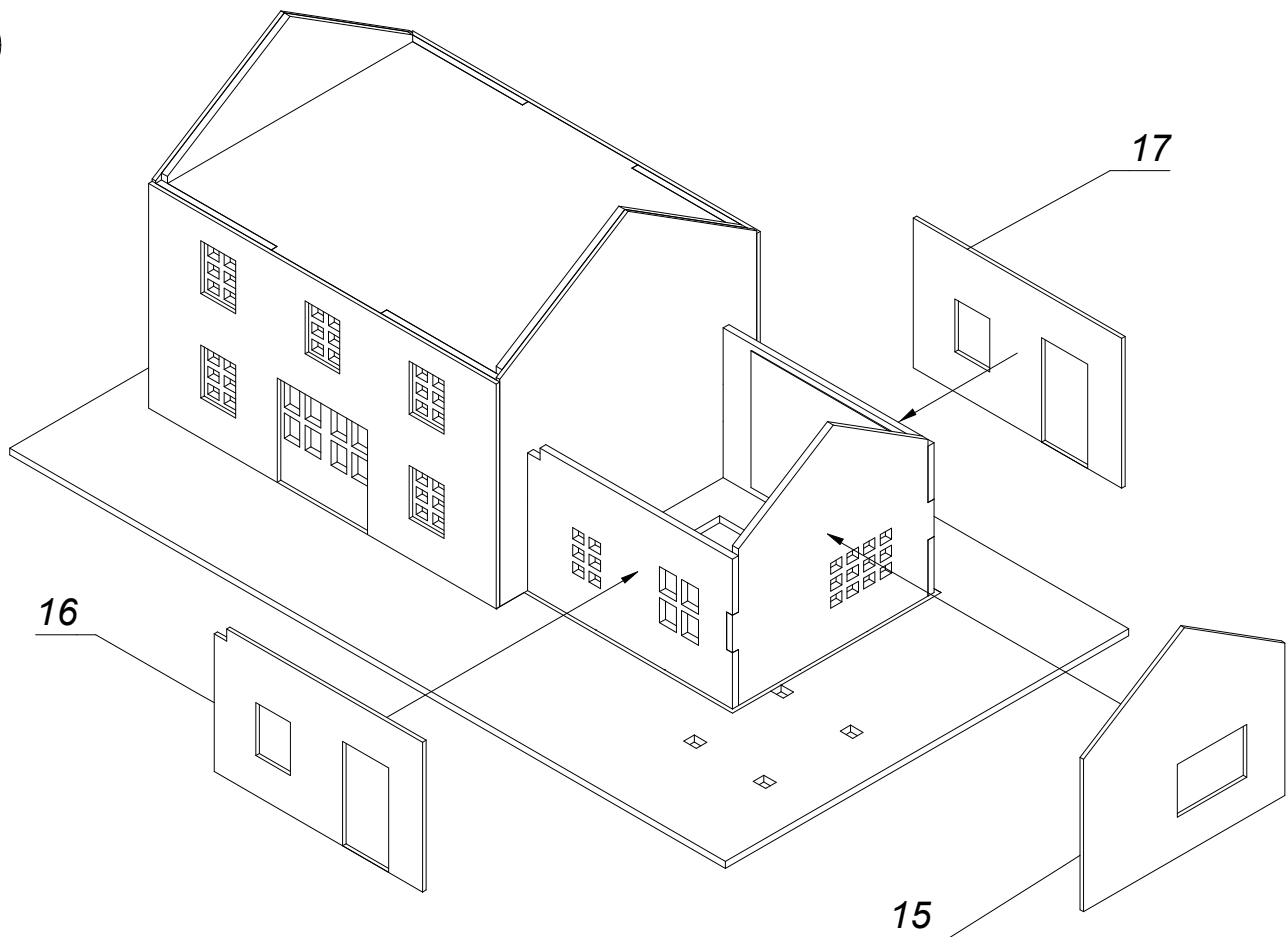

12.

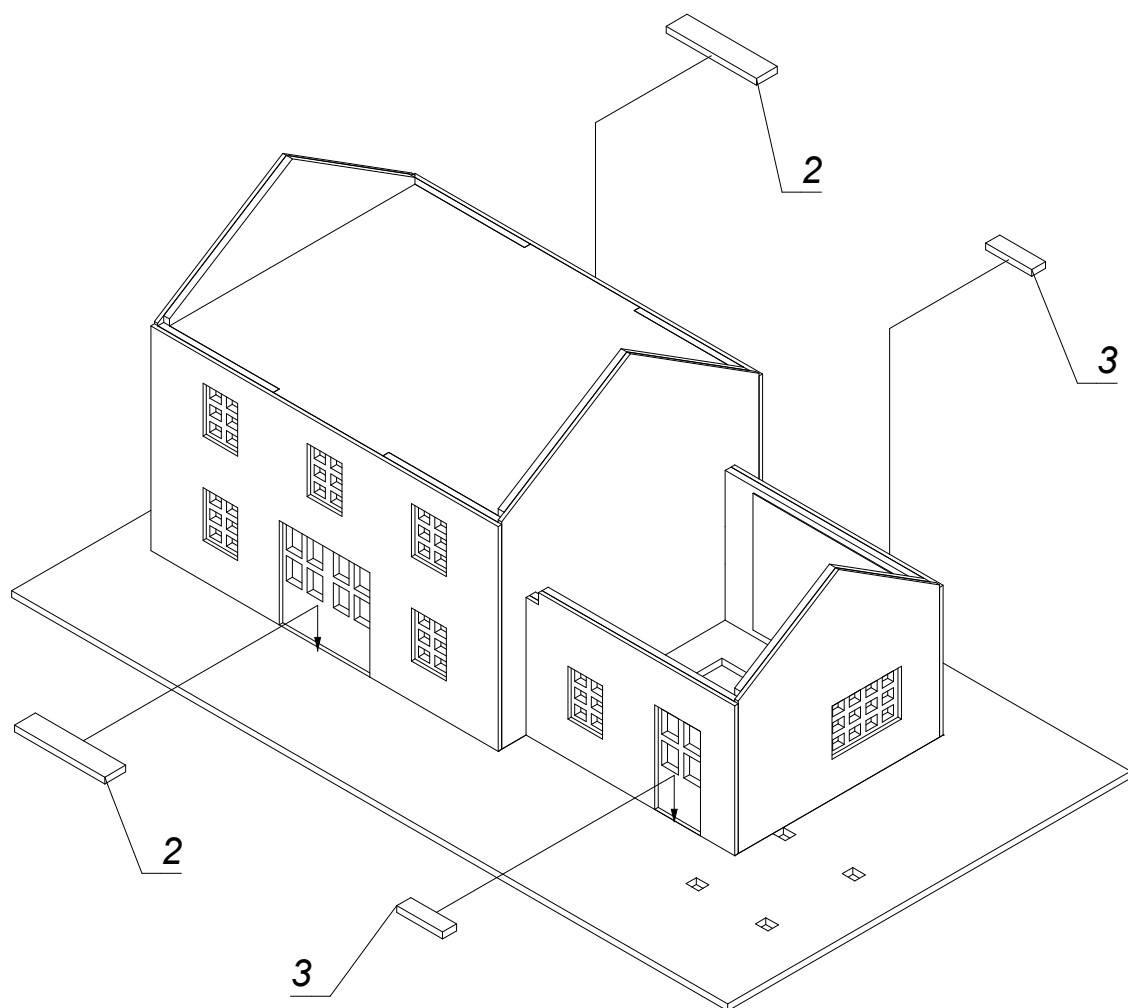

13.

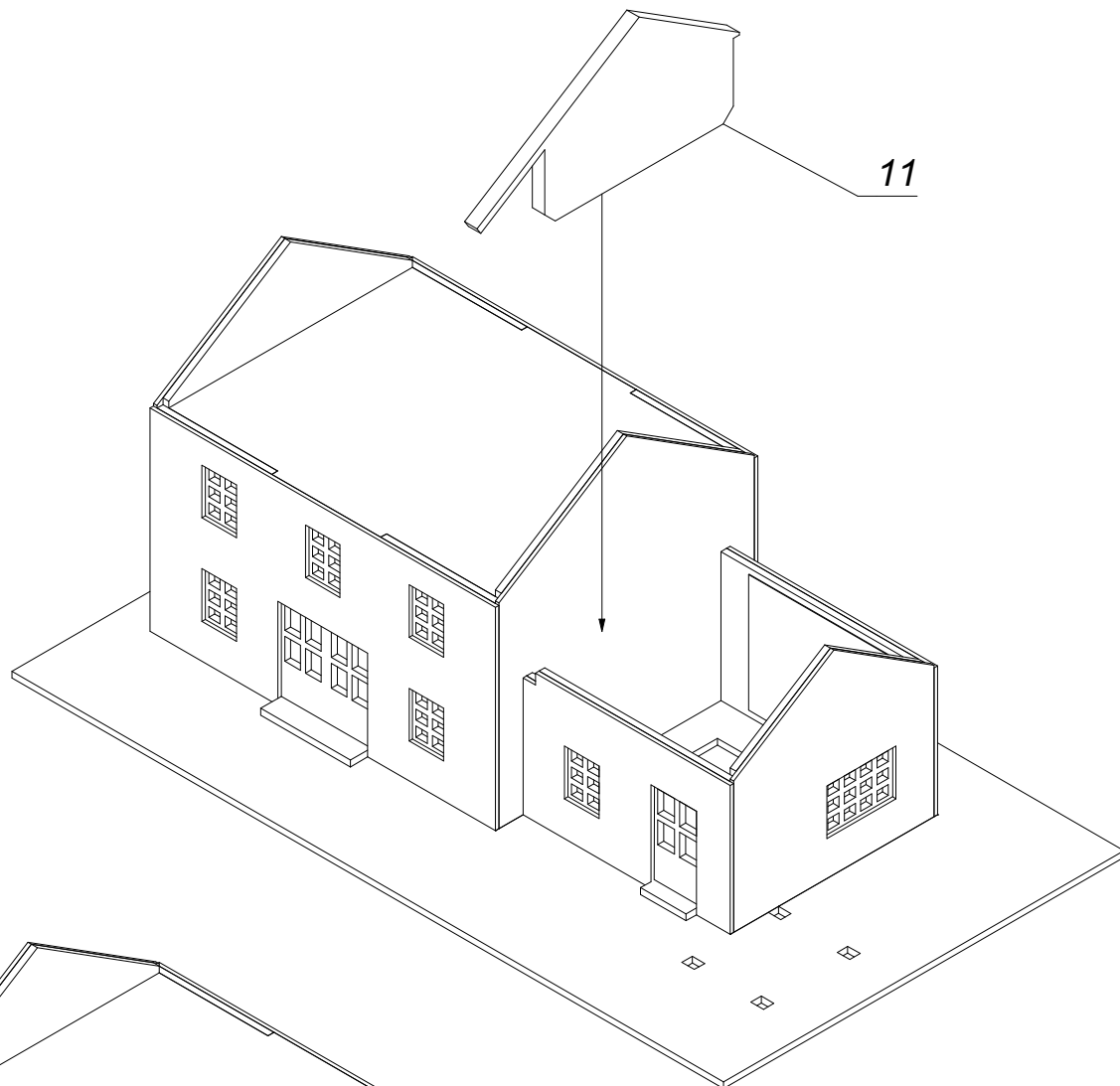

14.

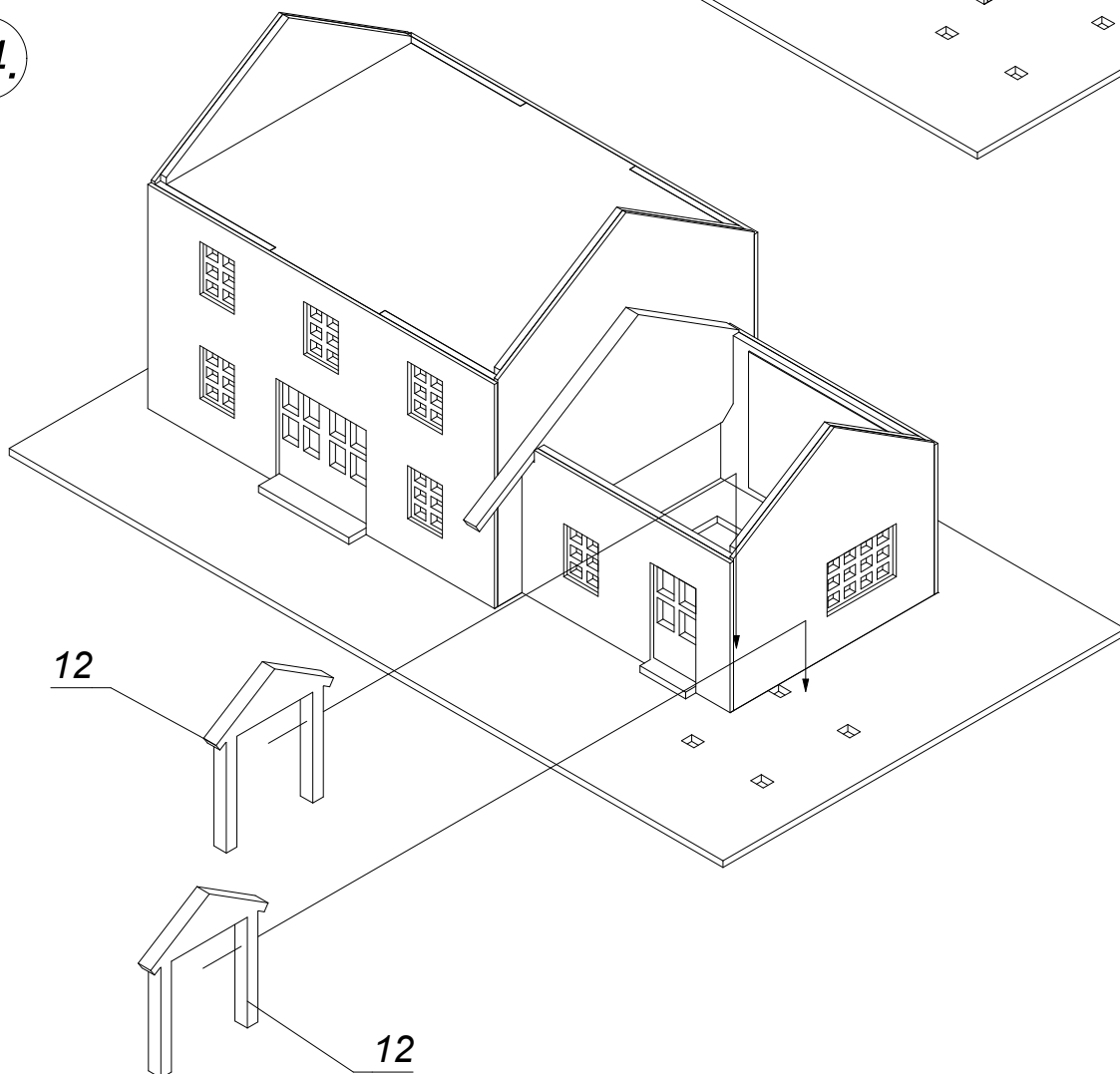

15.

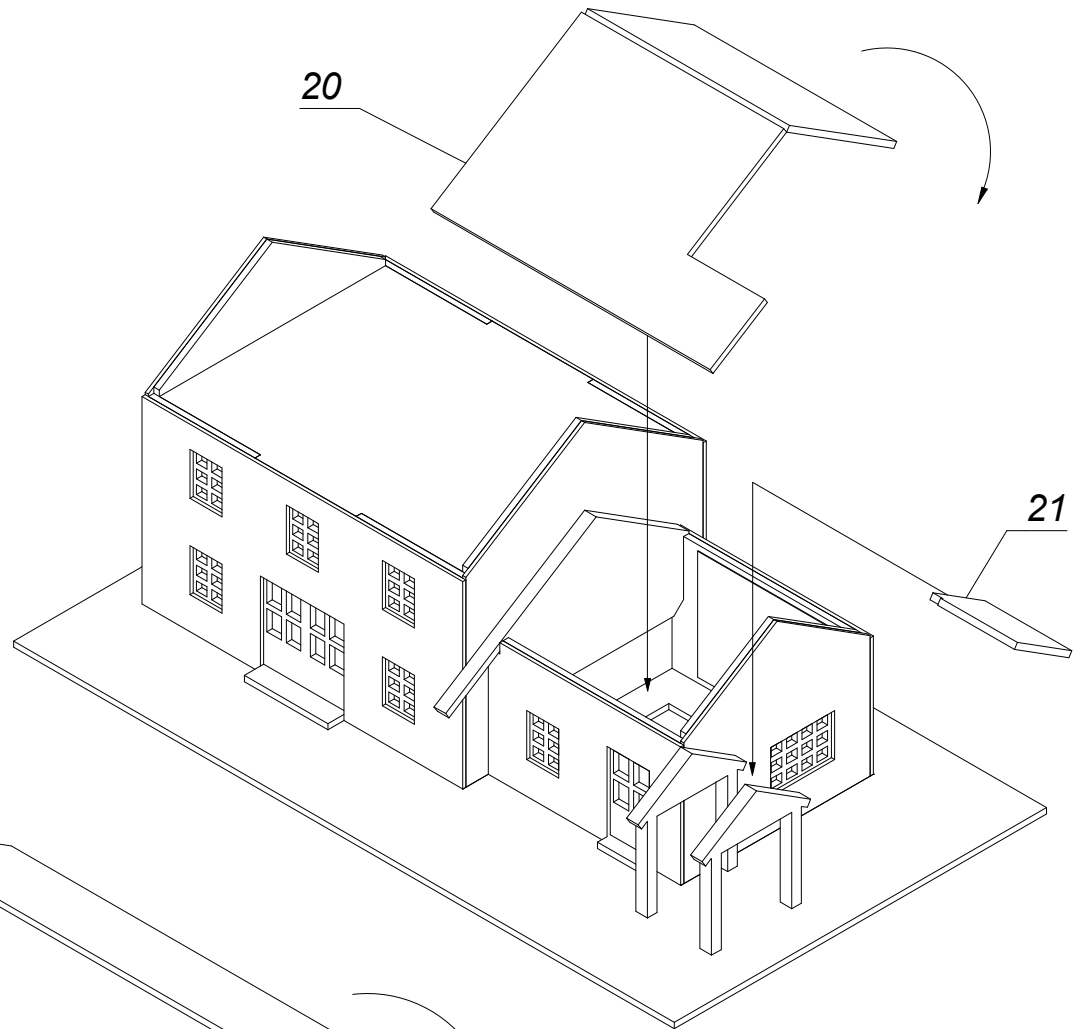

16.

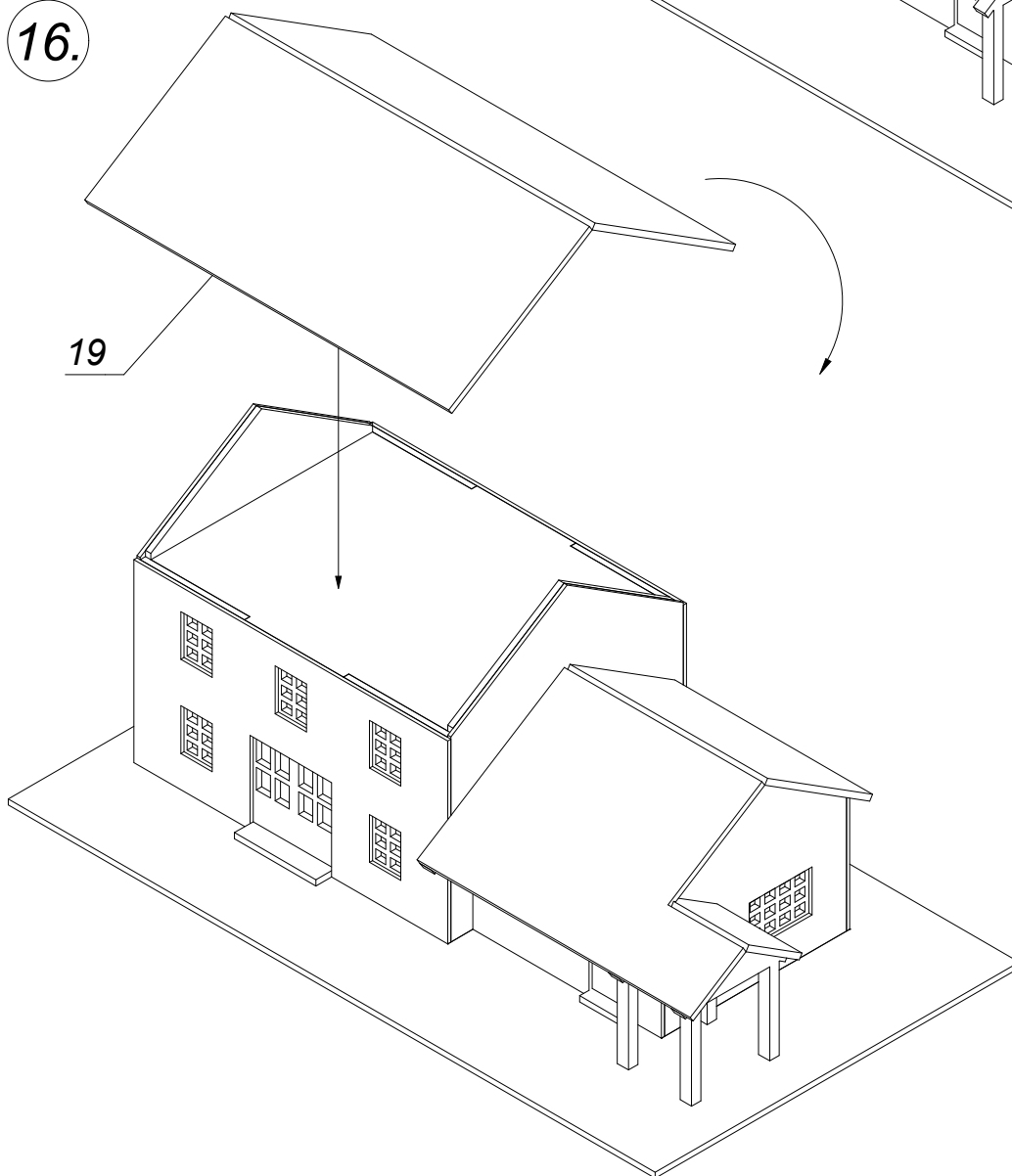

17.

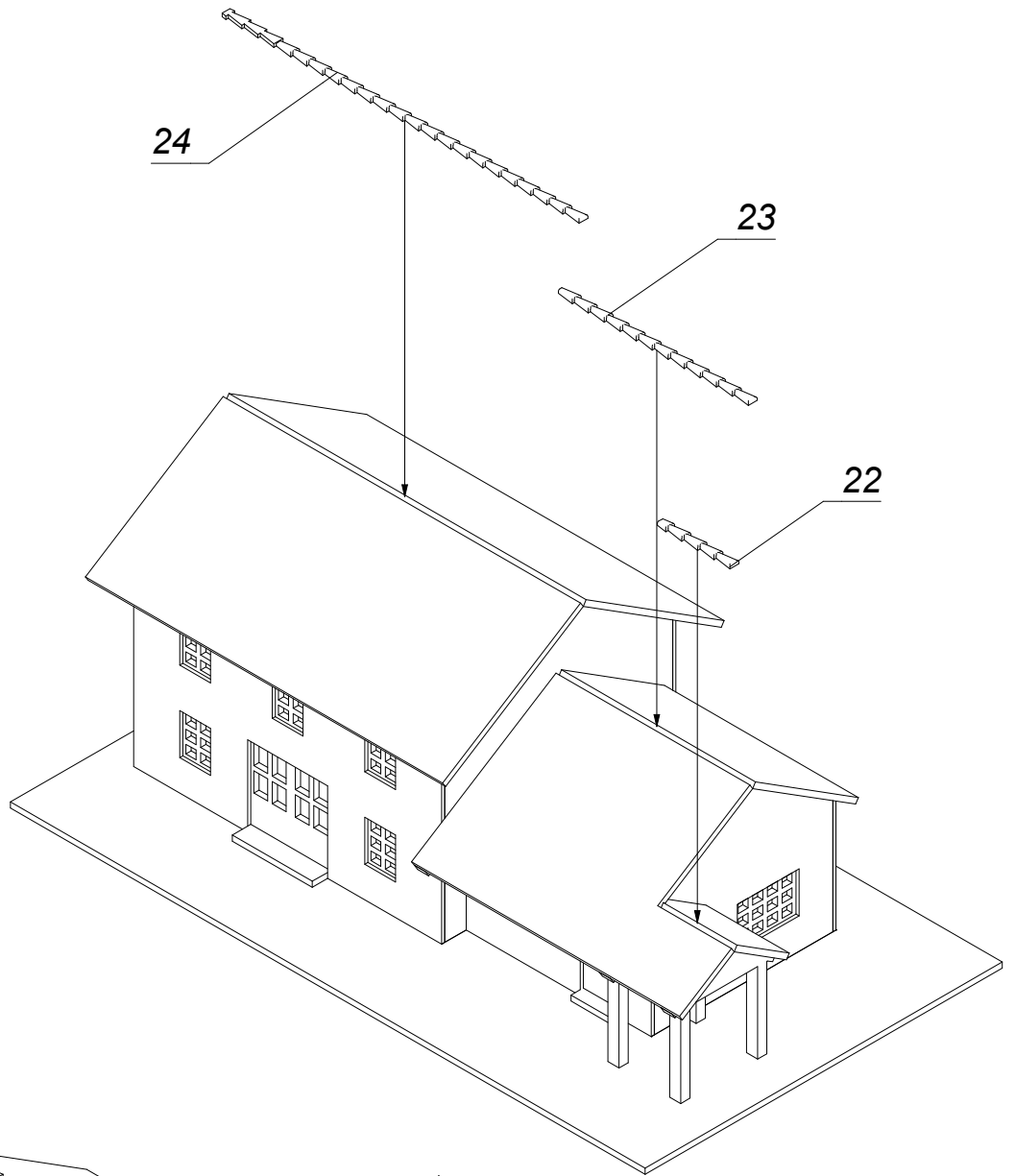

18.

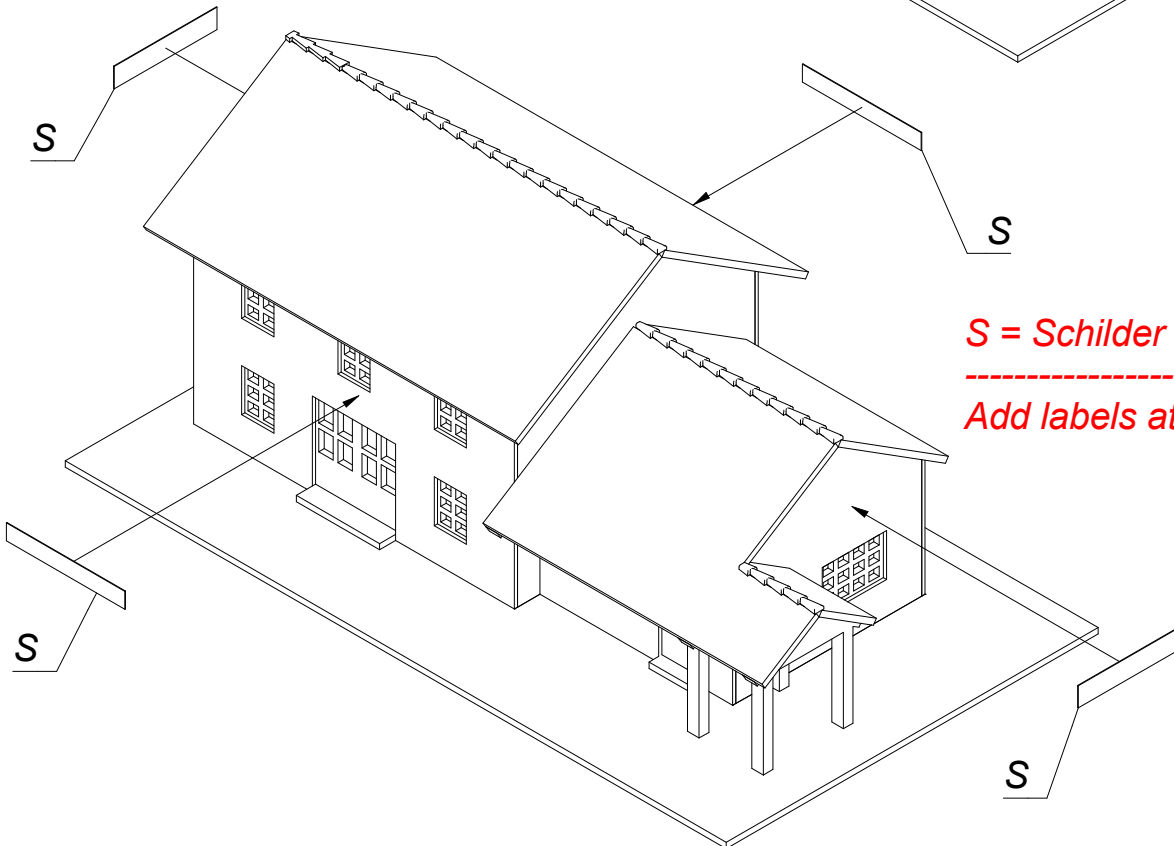

S = Schilder nach Wahl.

Add labels at your choice.

19.

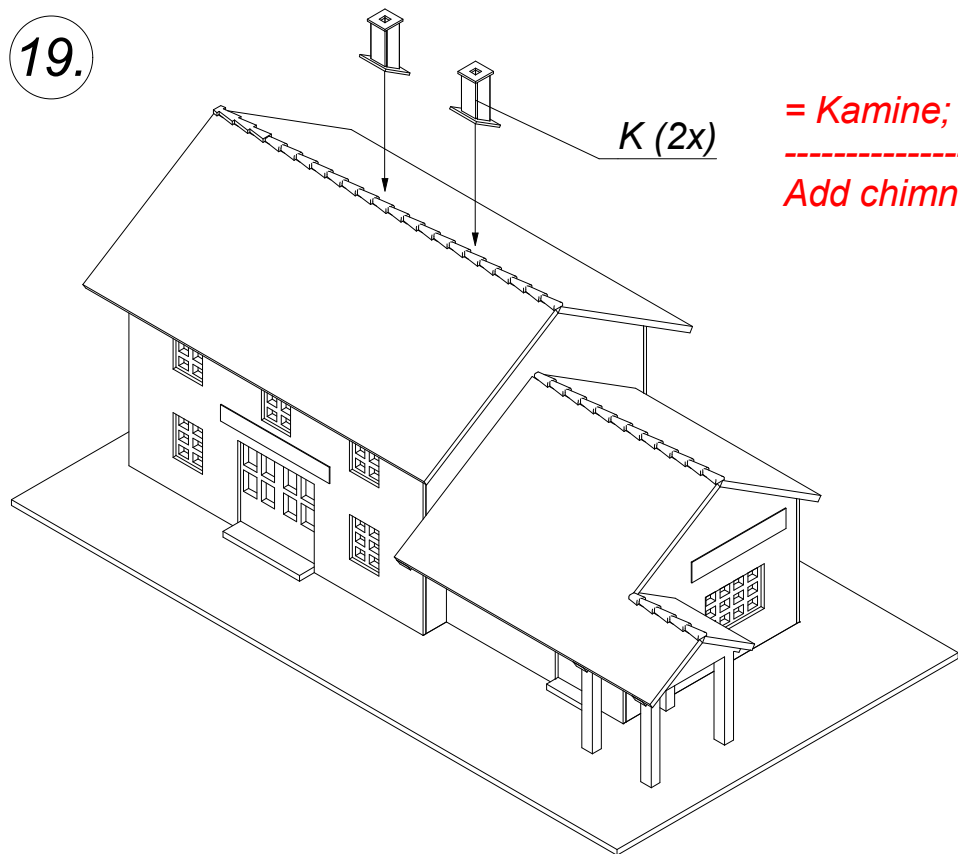

= Kamine; Position nach Wahl.

Add chimneys at your choice.

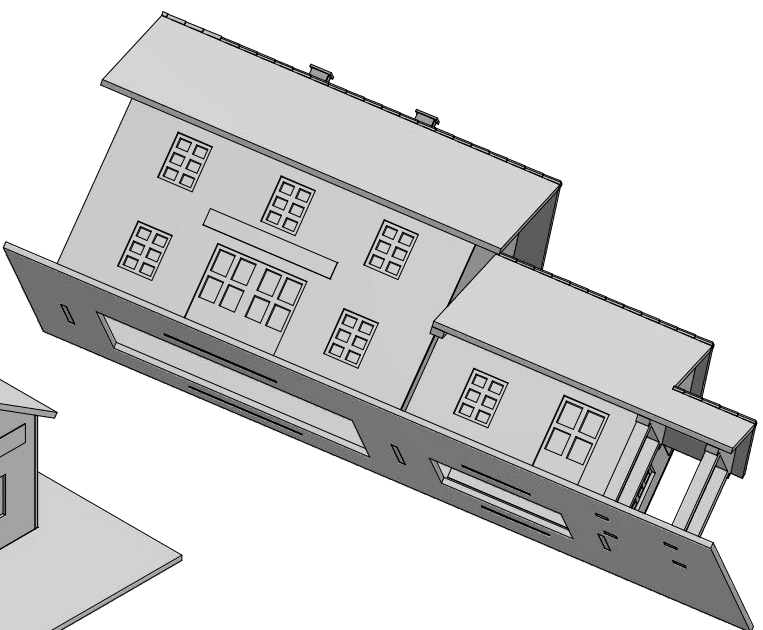
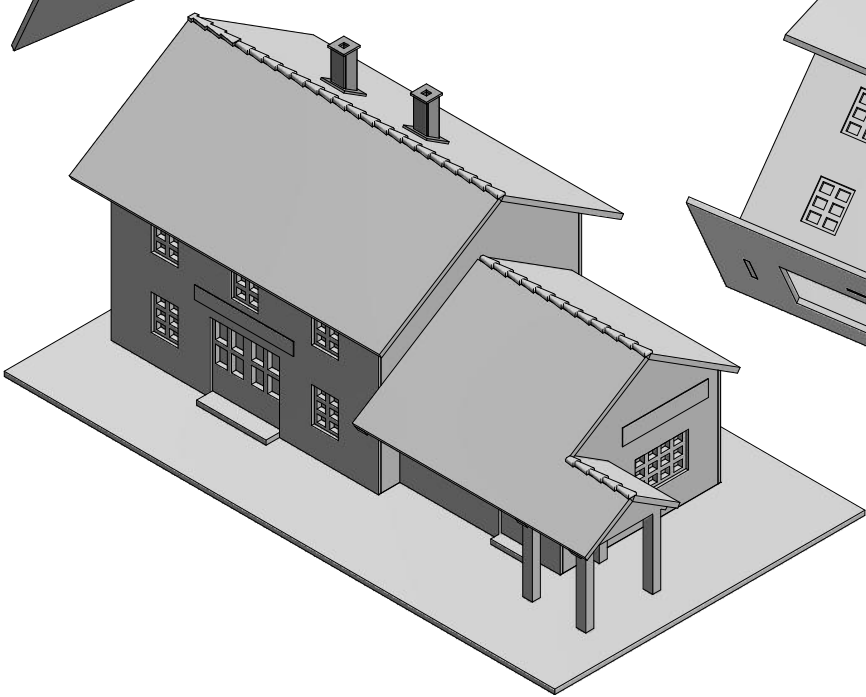
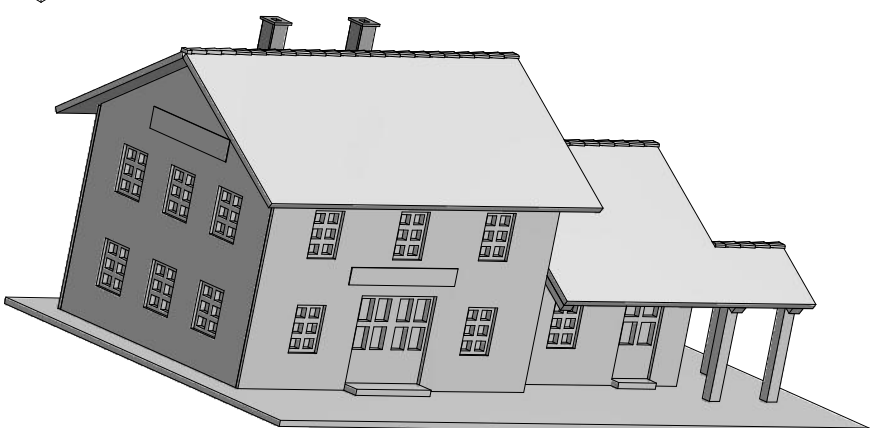
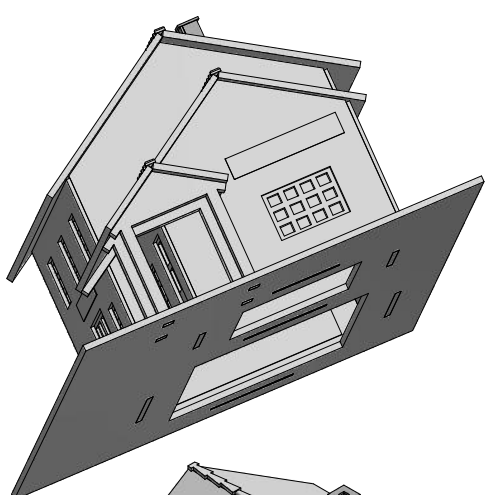



... wie im Original

Ebenfalls erhältlich · Also available:



Z 44310 *Dorf-Set, 3-teilig*
Village Set, 3 pieces



Z 44315 *Kleingebäude-Set, 3-teilig*
Small Buildings Set