



... wie im Original

65800 Bergrestaurant "Grosser Mythen" H0

Mountain Restaurant "Grosser Mythen" H0

L'auberge de montagne "Grosser Mythen" H0

Restaurante de Montaña "Grosser Mythen" H0

Bergrestaurant "Grosser Mythen" H0



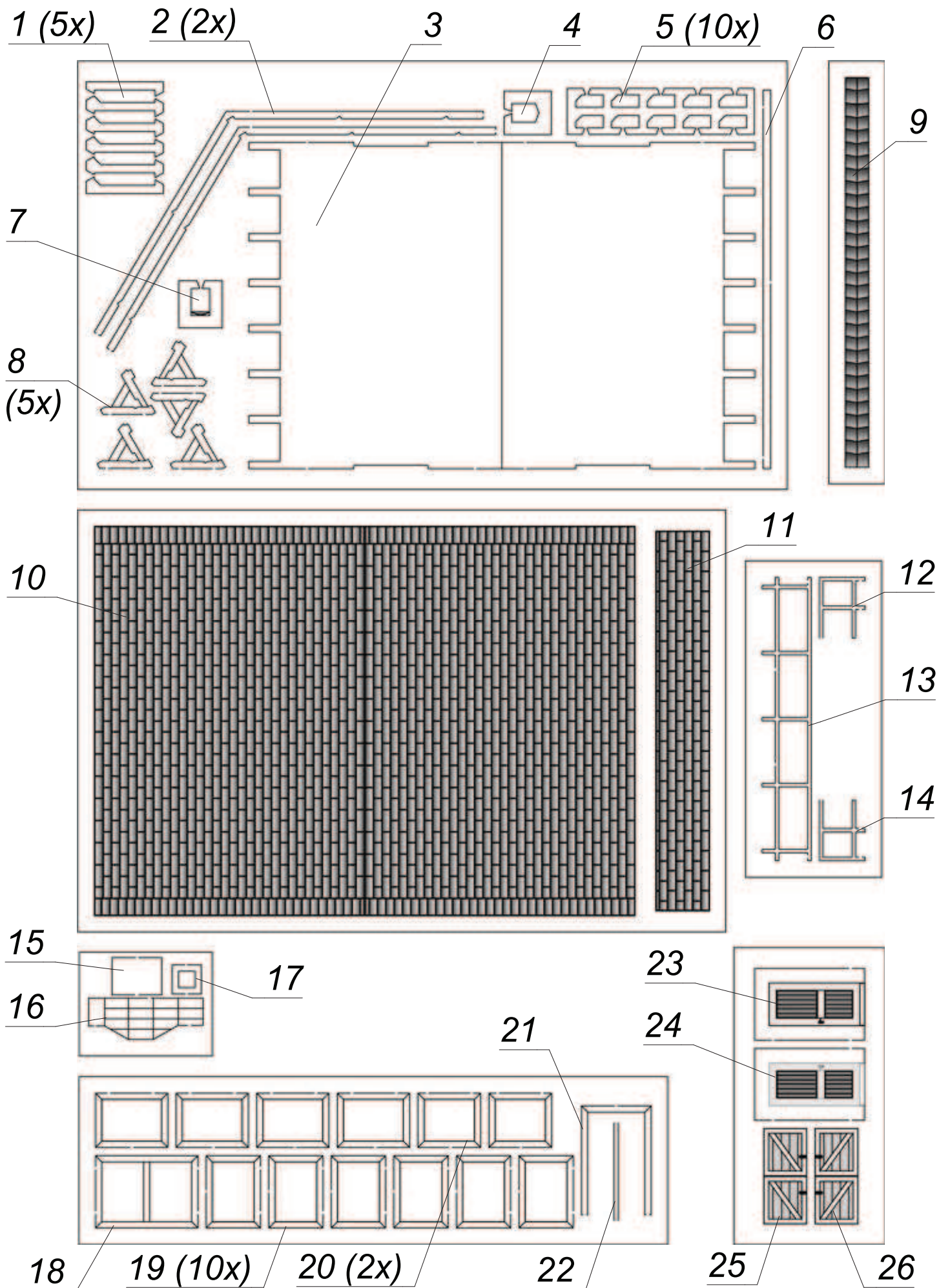

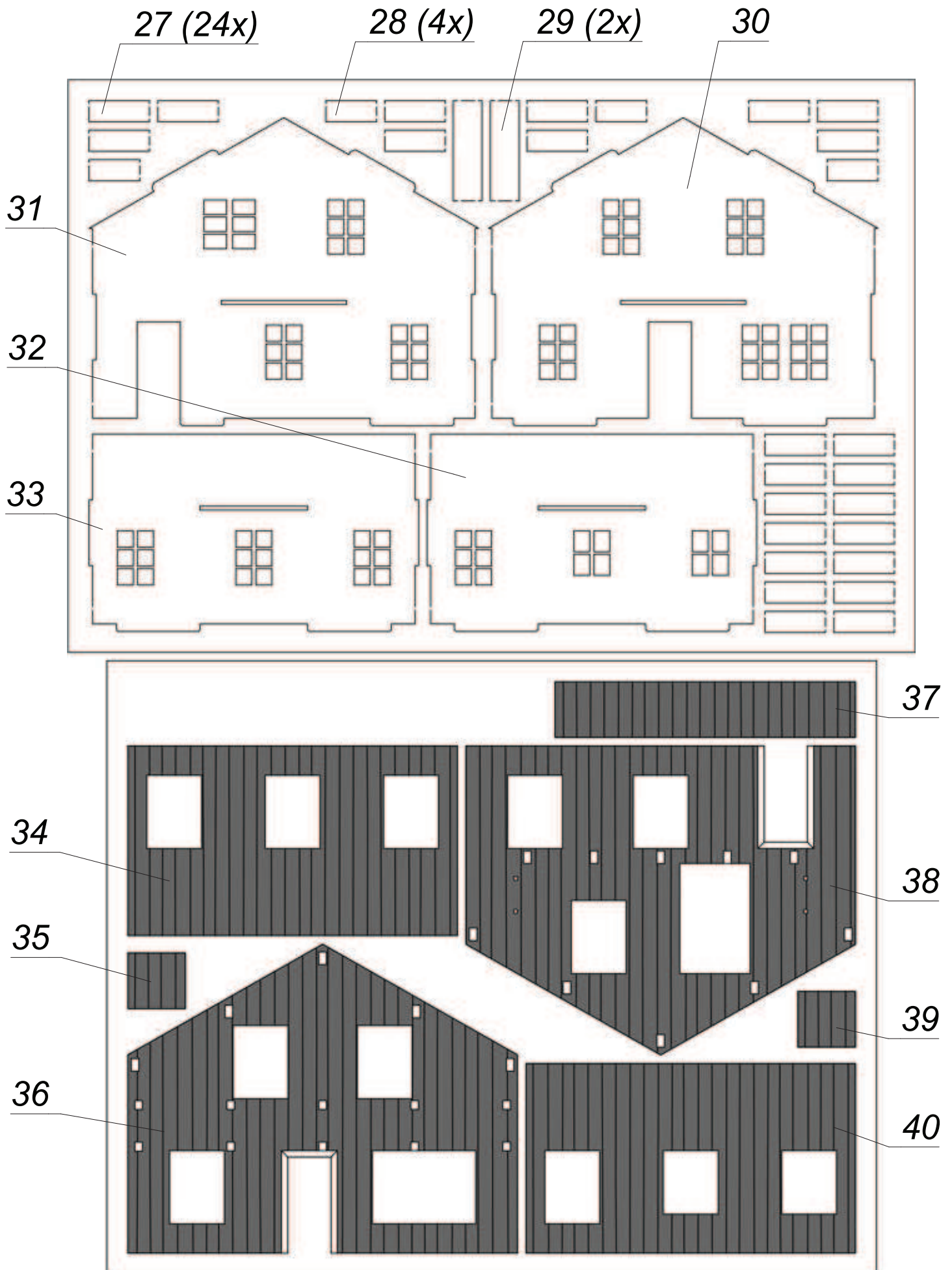

41

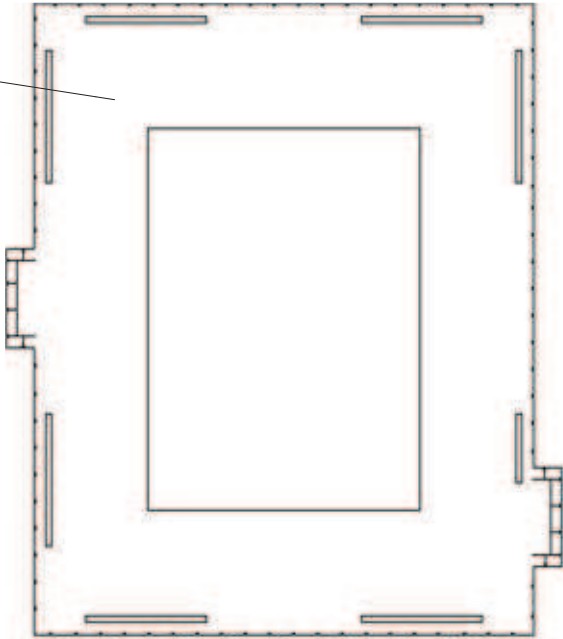

42

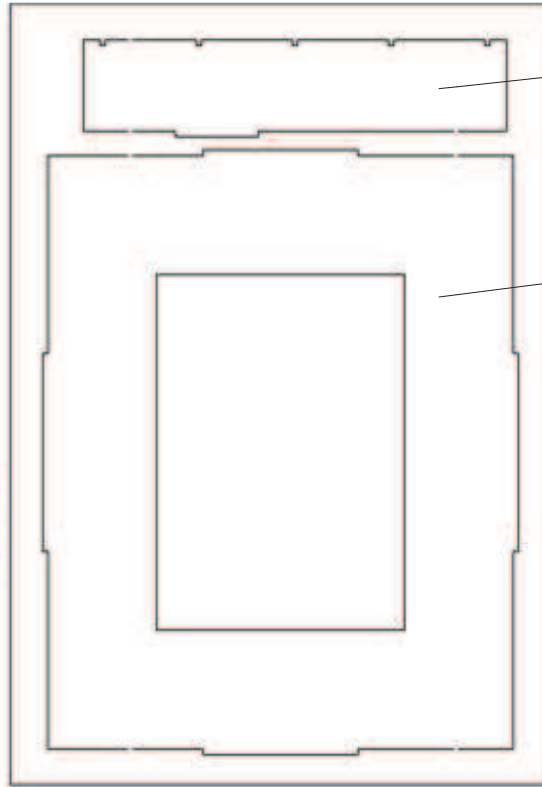

43

44



45

(2x)



R



Klarsichtfolie
Transparency film

G

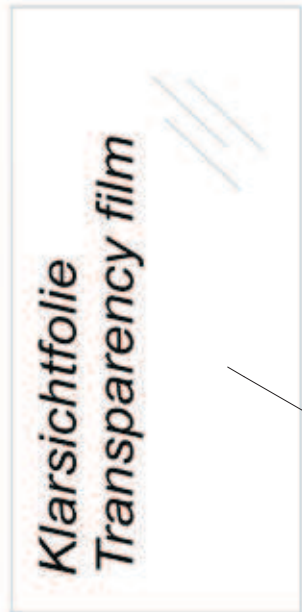

Z

DB



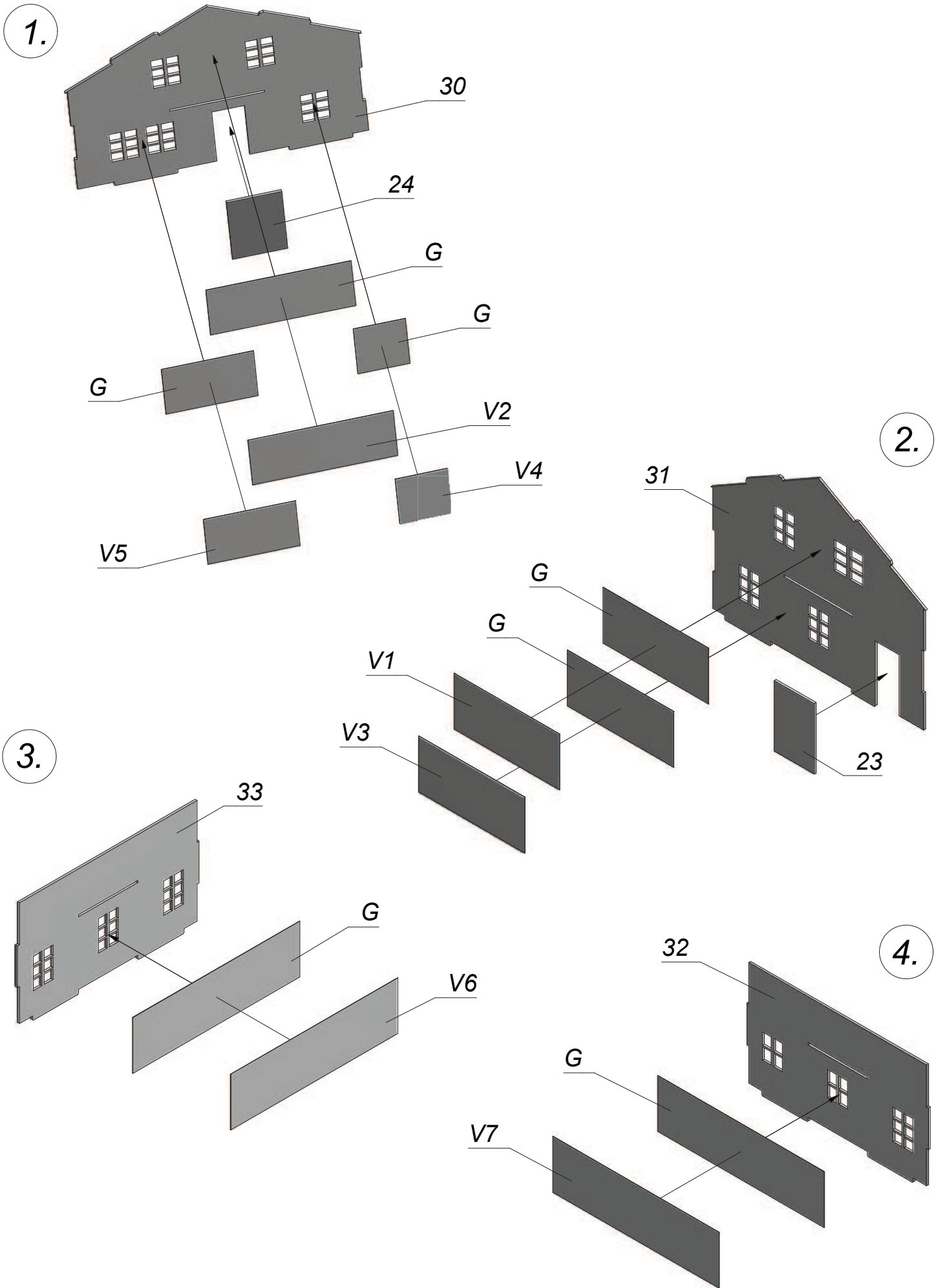

5. **Achtung!**
Teil 33 und 32 richtig ausrichten! Sie sind **nicht** formgleich (Fenster).

Attention!
Add parts 33 and 32 in the correct position! They are **different** (windows).

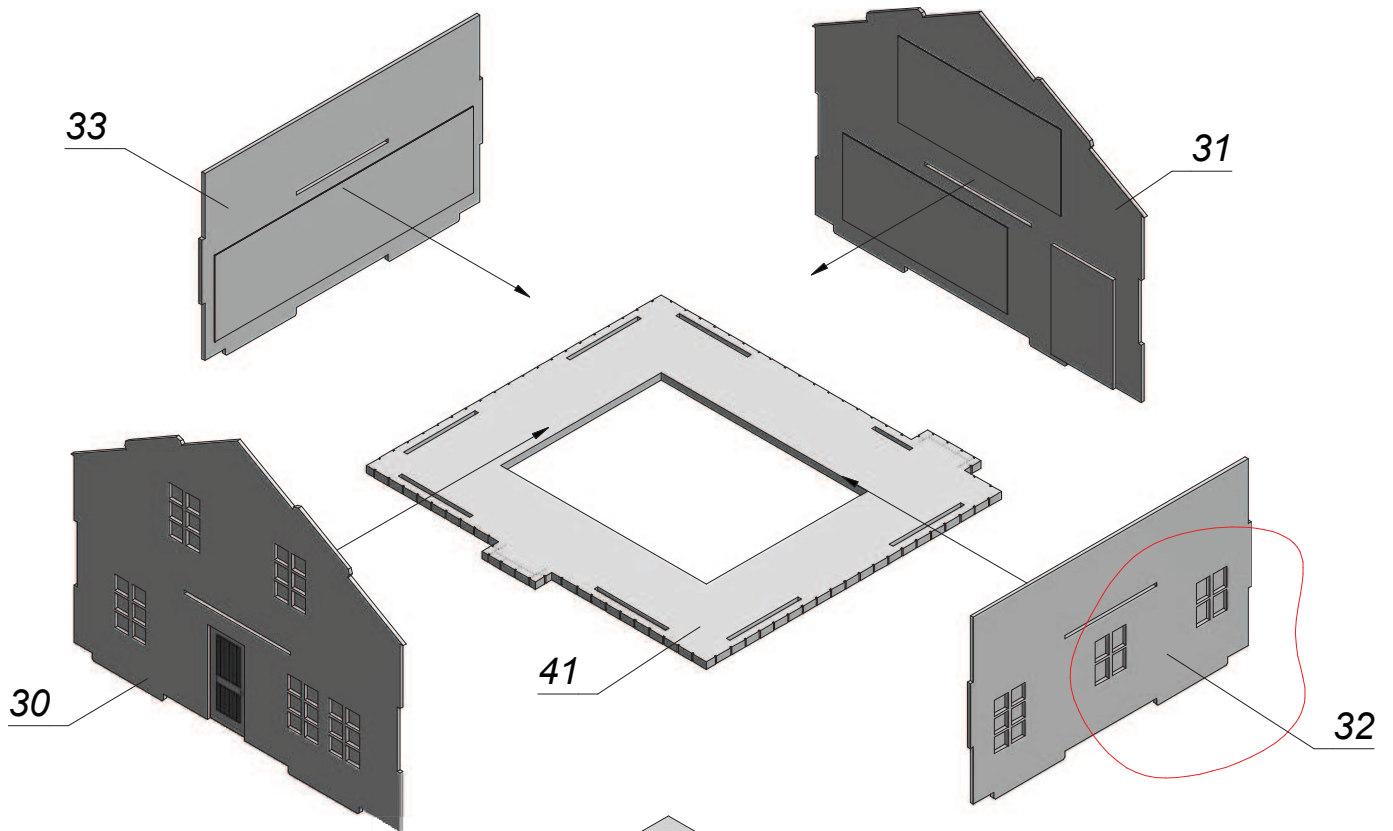

6.

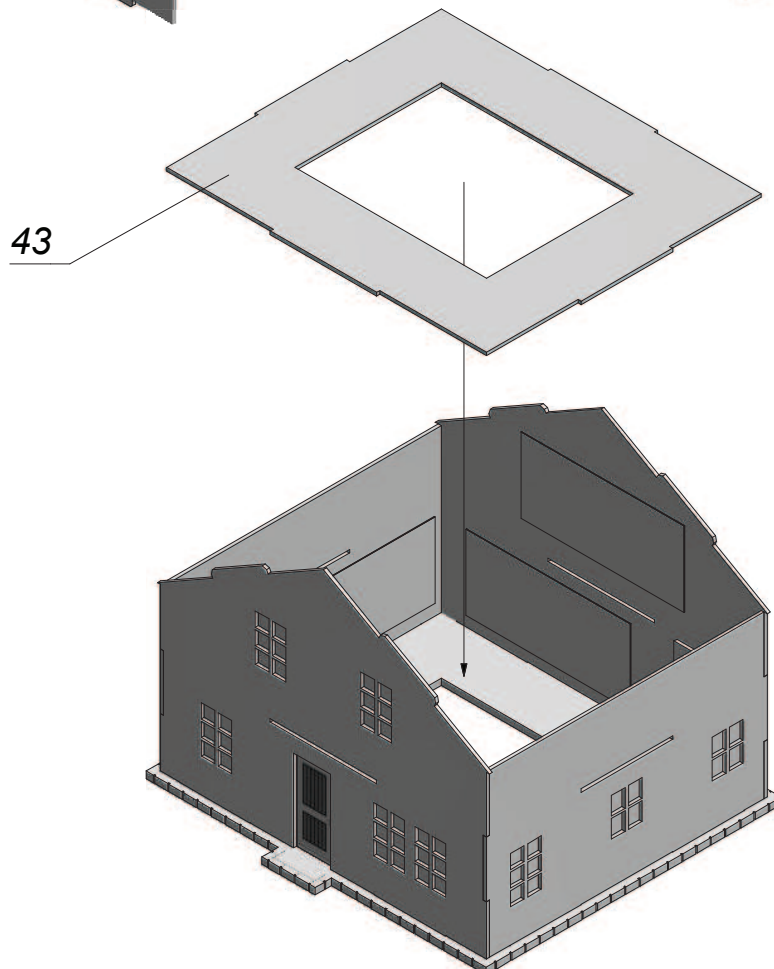

7.

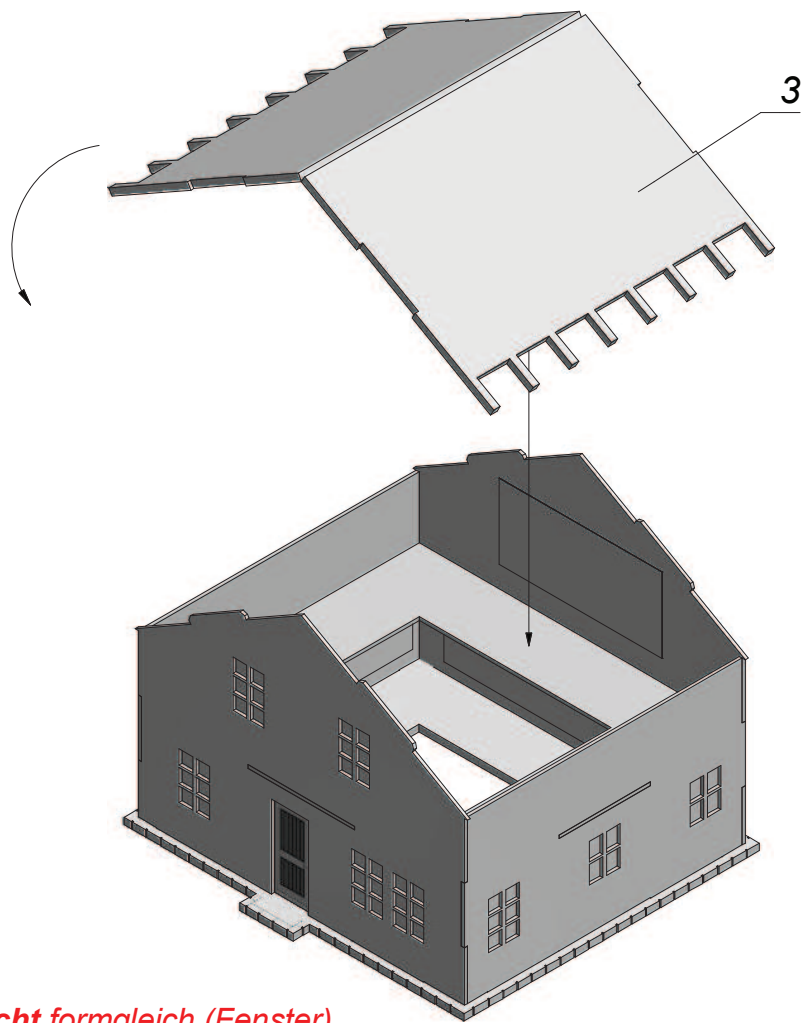

8.

Achtung!
Teil 34 und 40 richtig ausrichten! Sie sind **nicht** formgleich (Fenster).

Attention!
Add parts 34 and 40 in the correct position! They are **different** (windows).

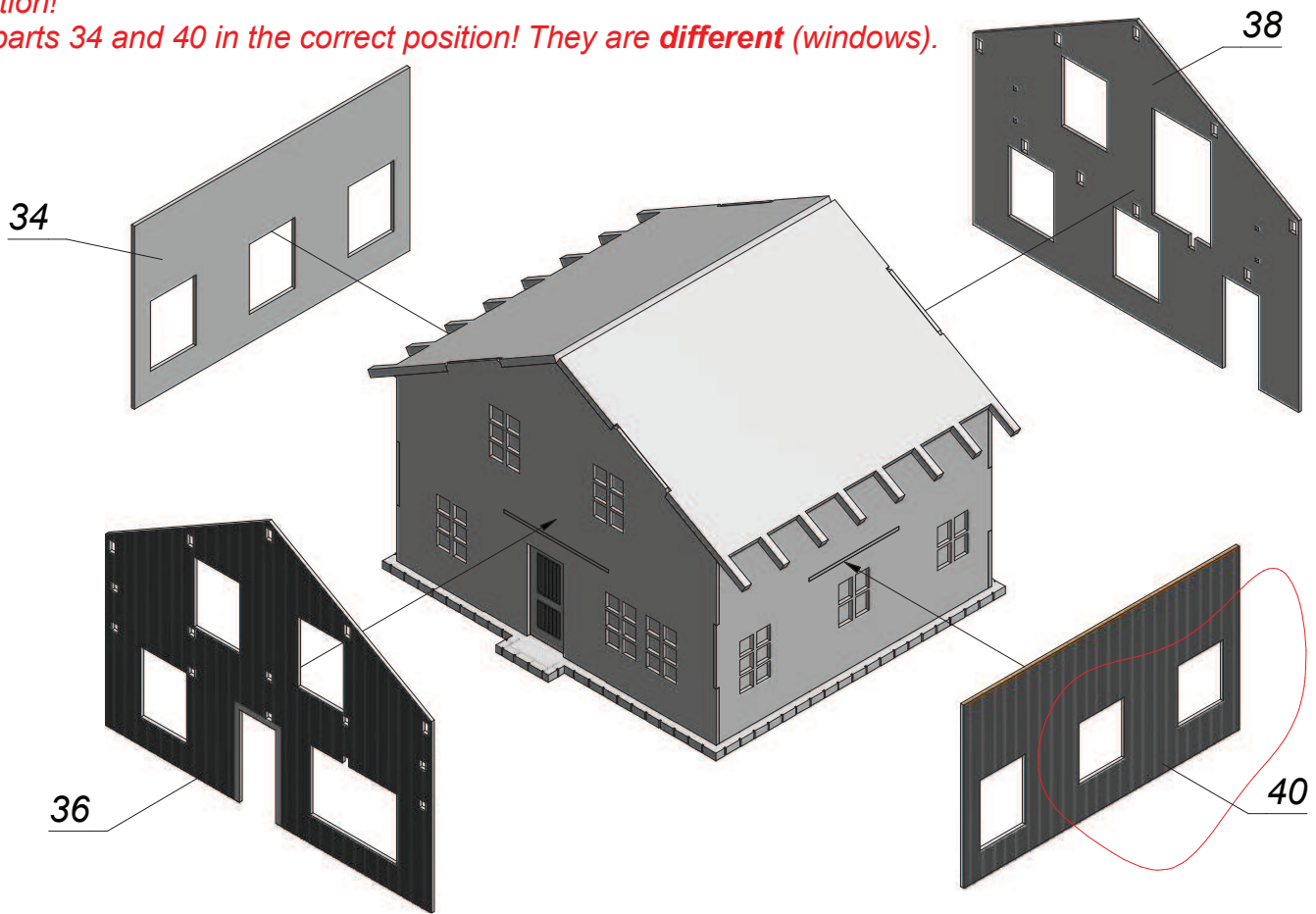

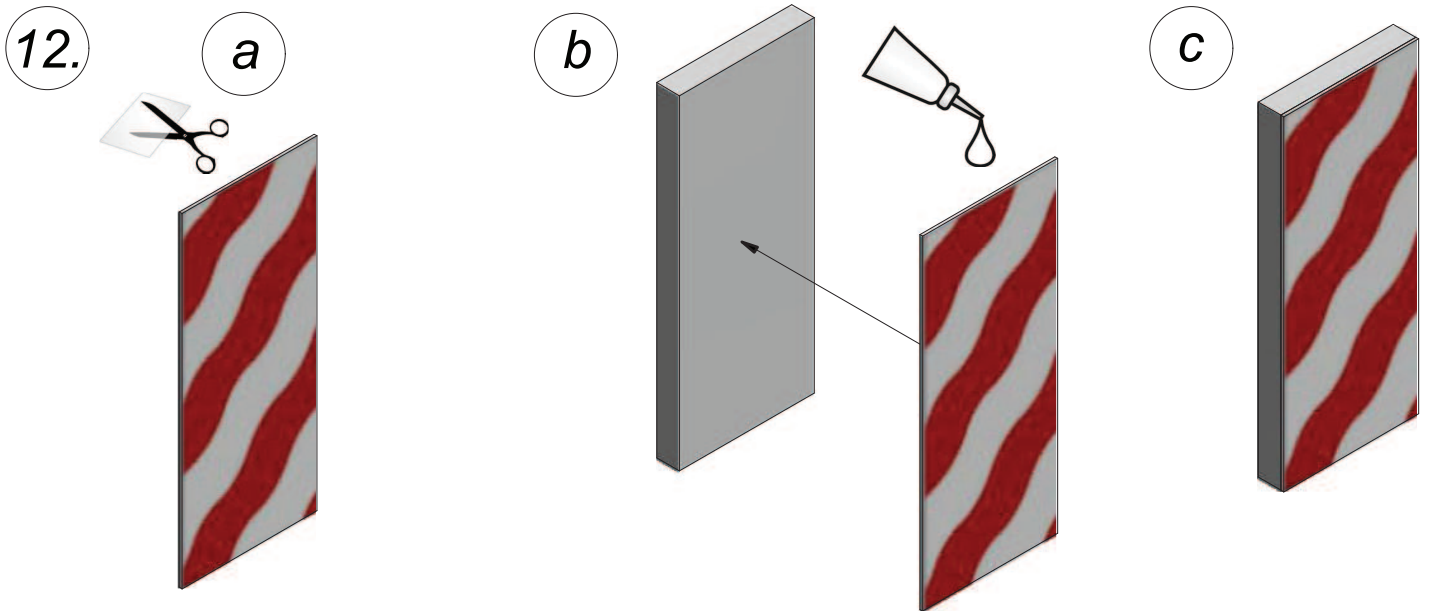

FL1 (2x): 24 mm x 7 mm - Teil / part 29
FL2 (4x): 12 mm x 5 mm - Teil / part 28
FL3 (24x): 14 mm x 5 mm - Teil / part 27

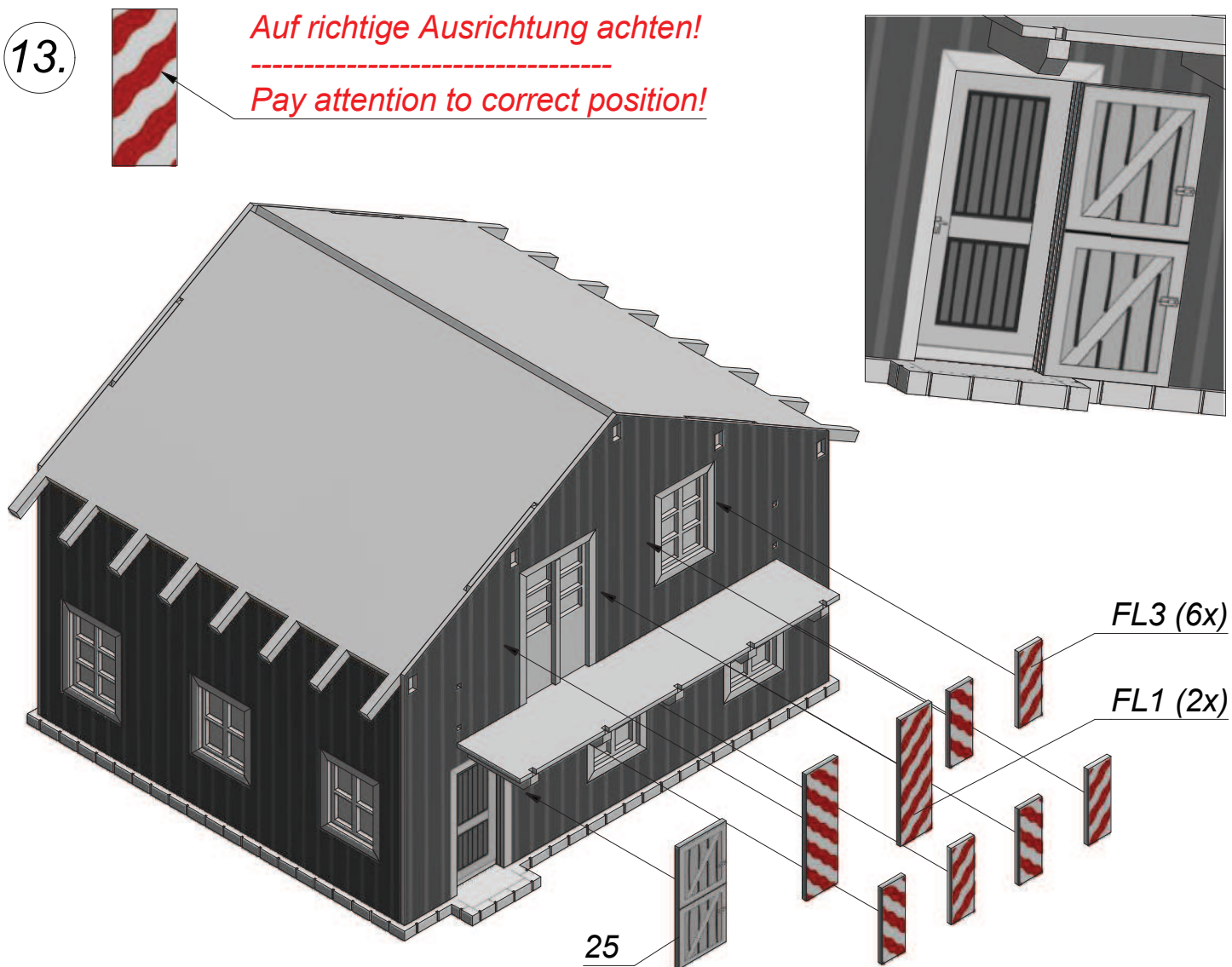

14.

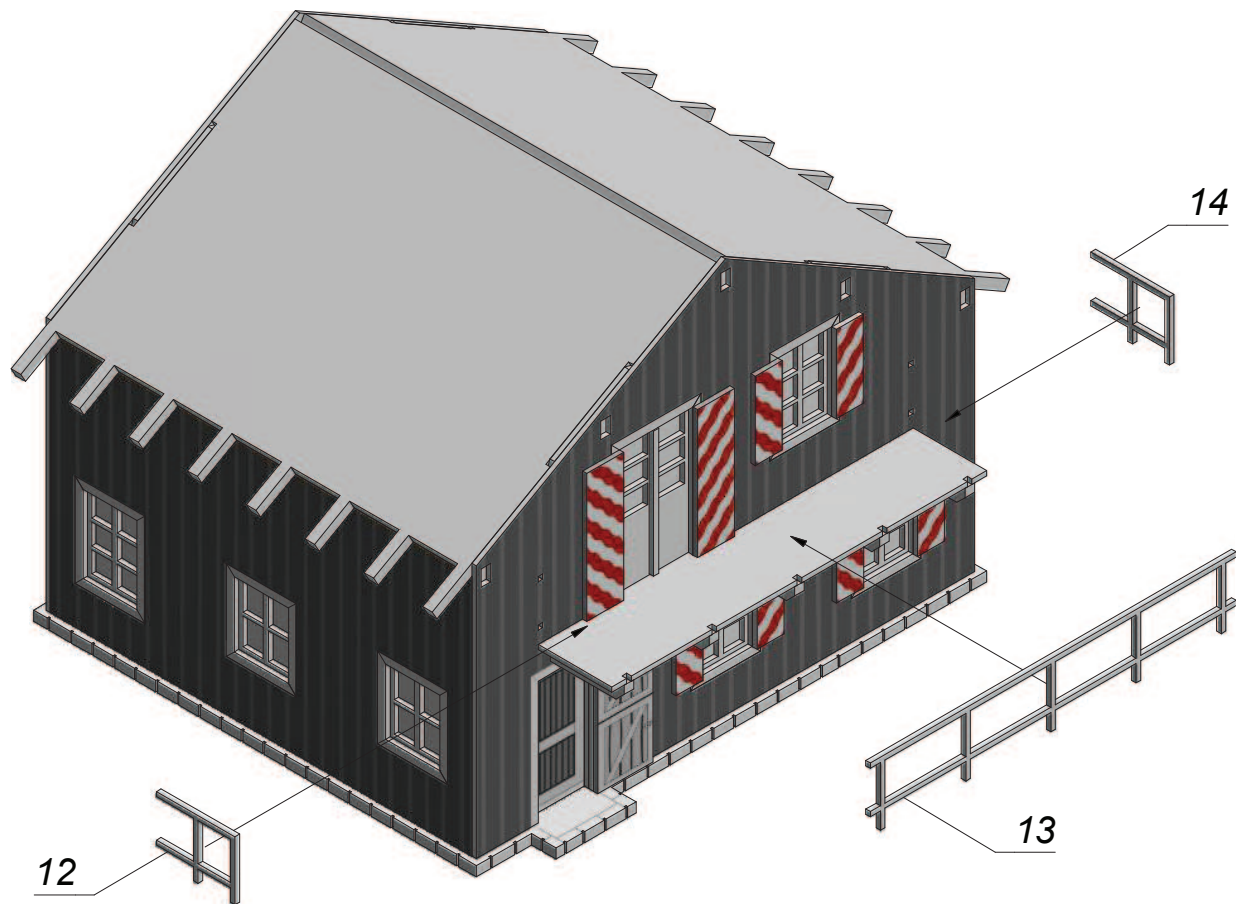

15.

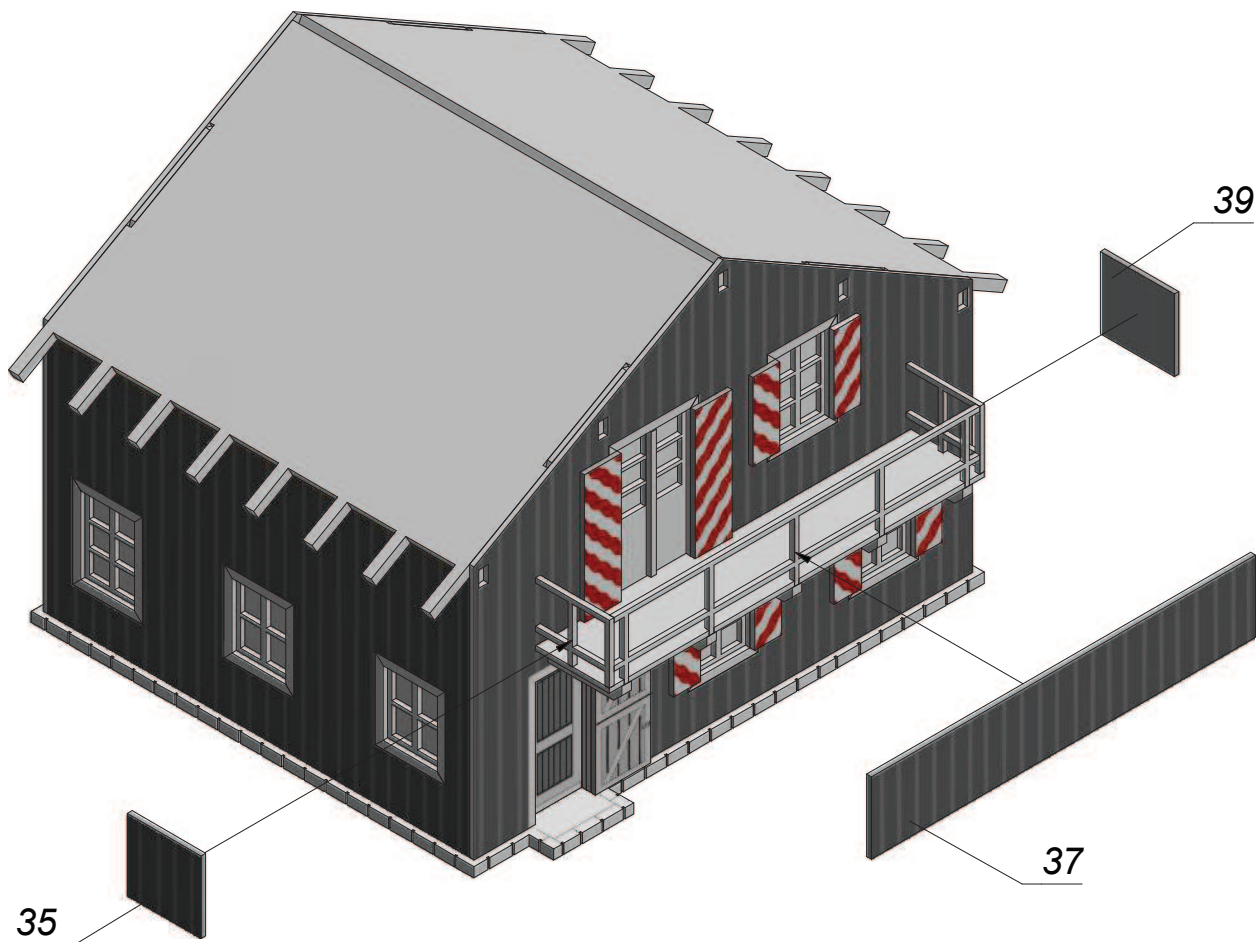

16.

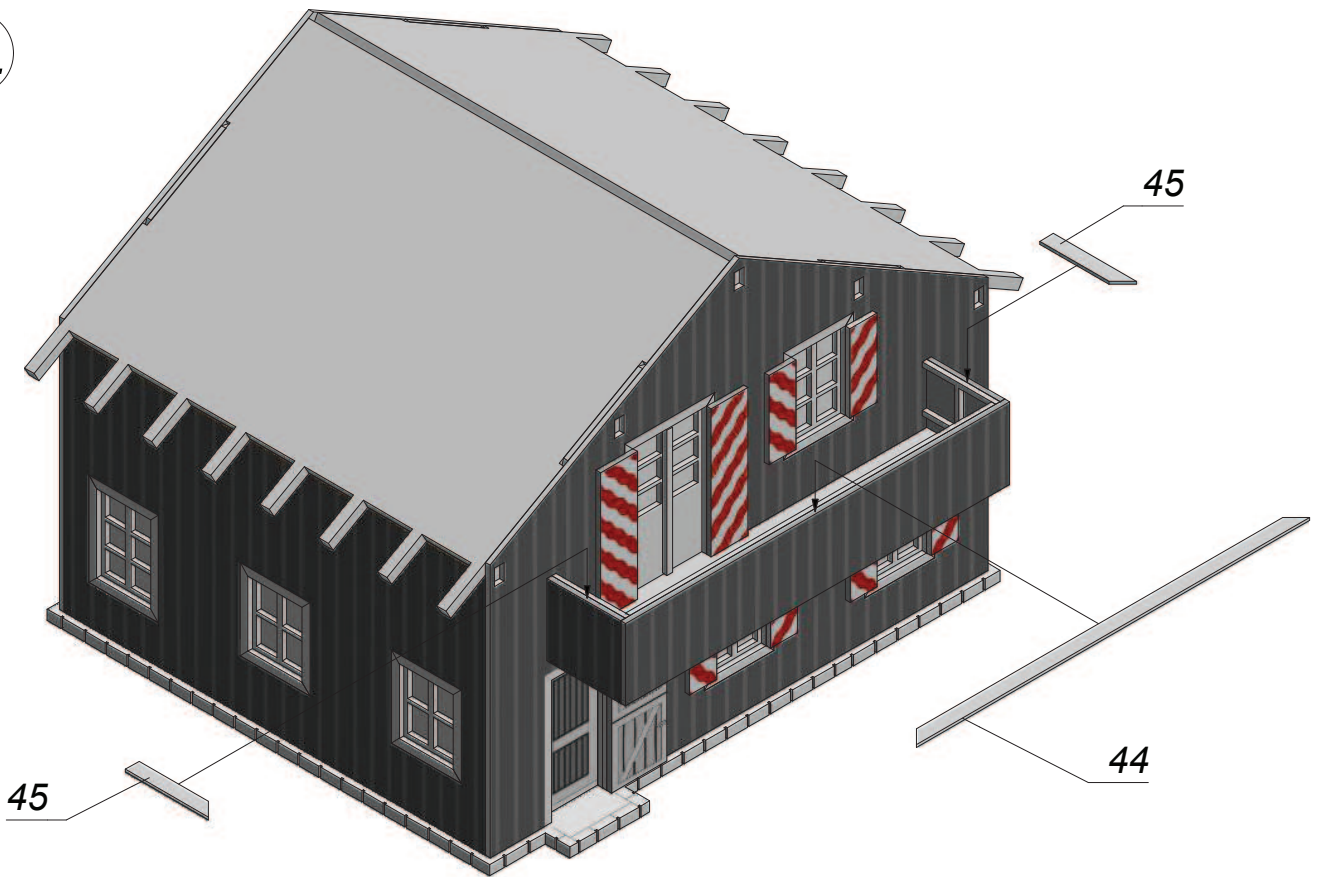

17.

FL3 (6x)

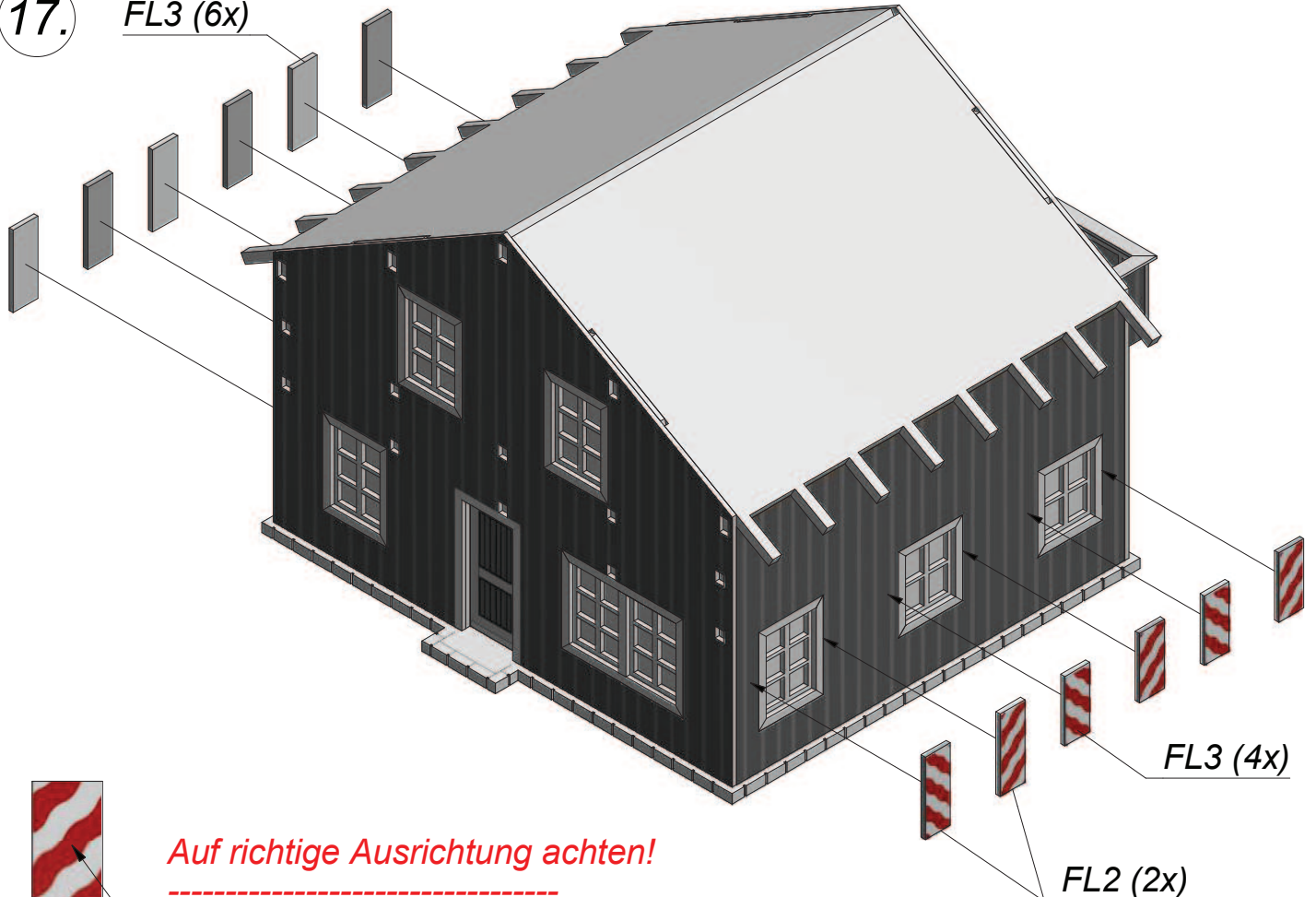

Auf richtige Ausrichtung achten!

Pay attention to correct position!

18.

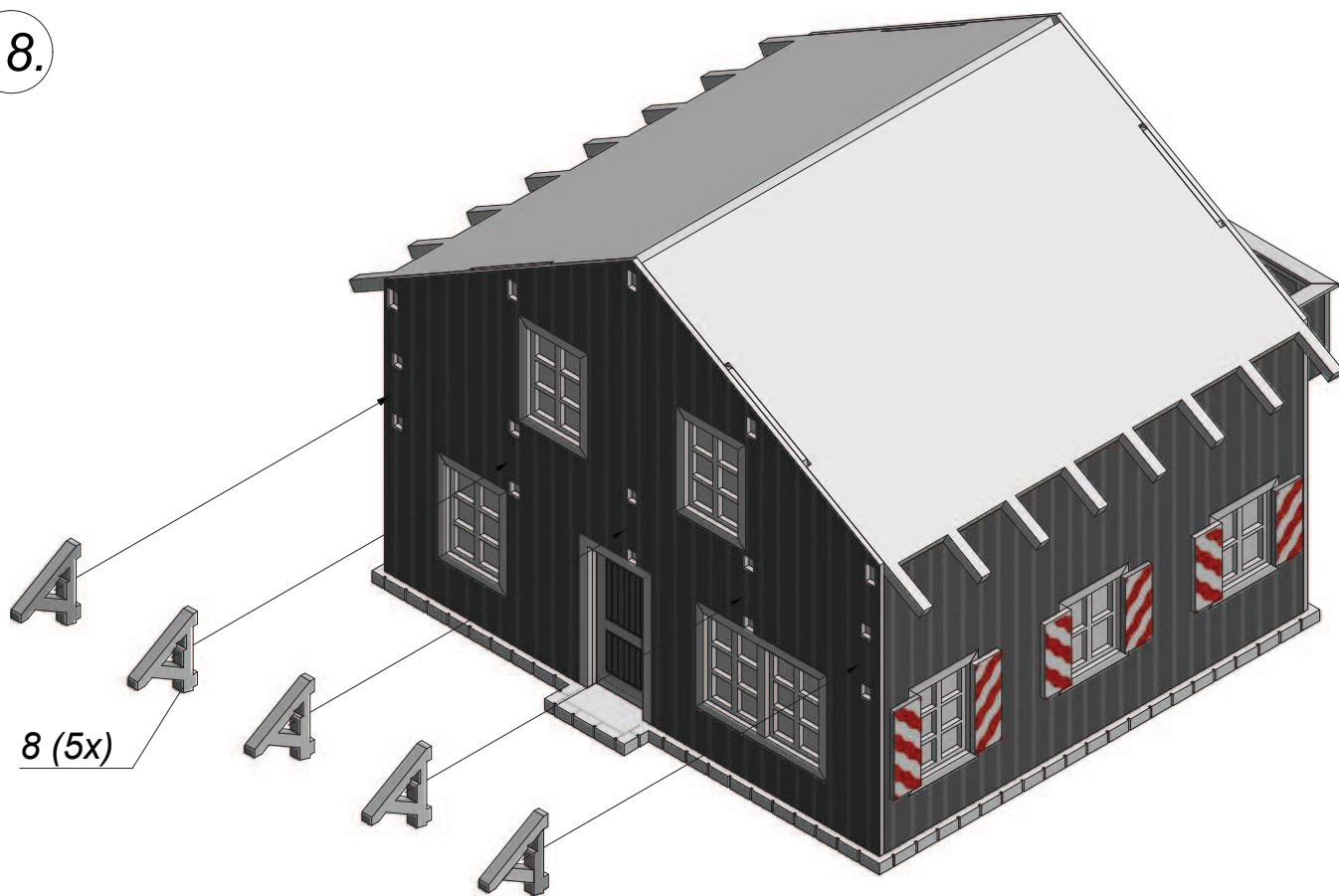

19.

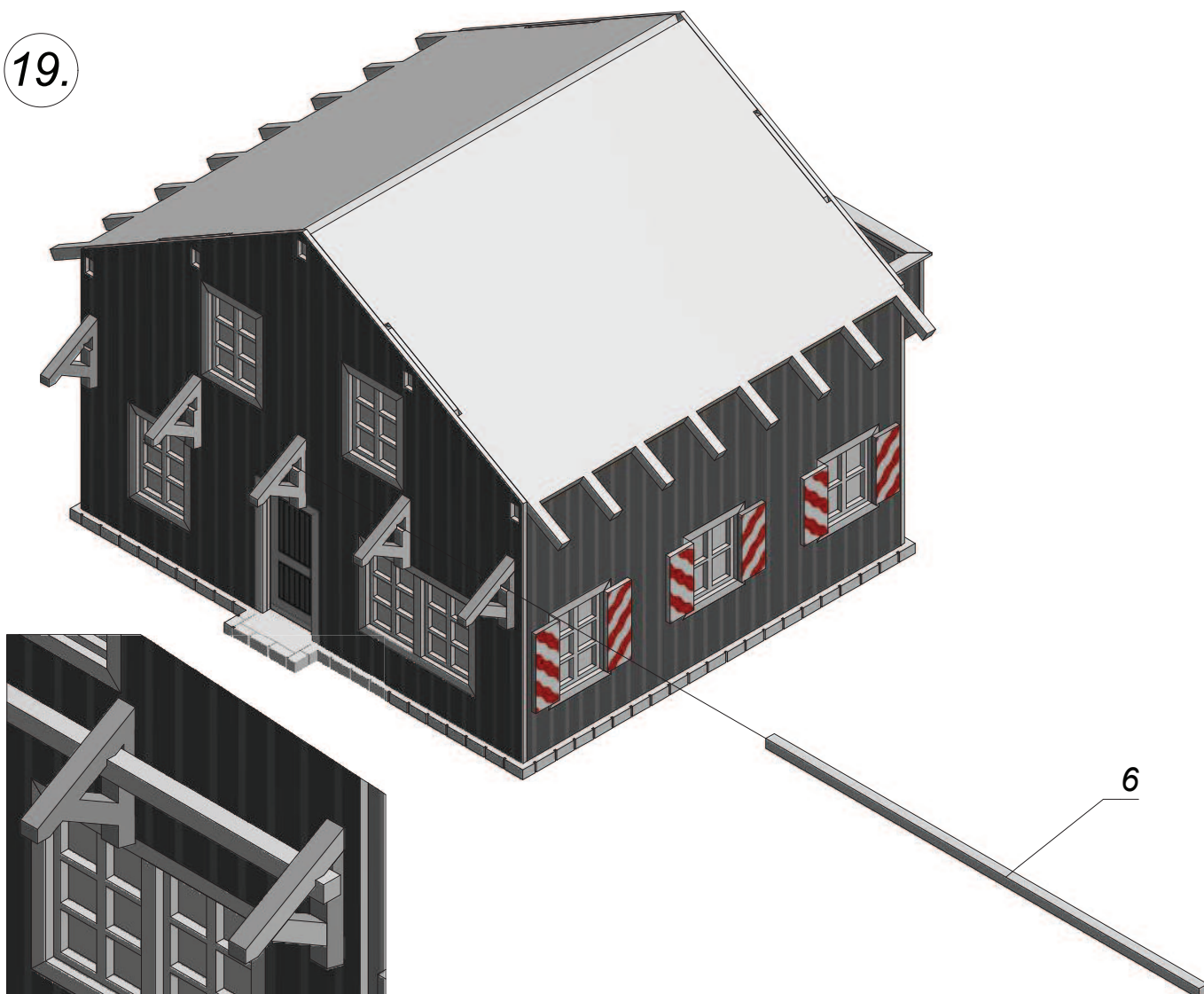

20.

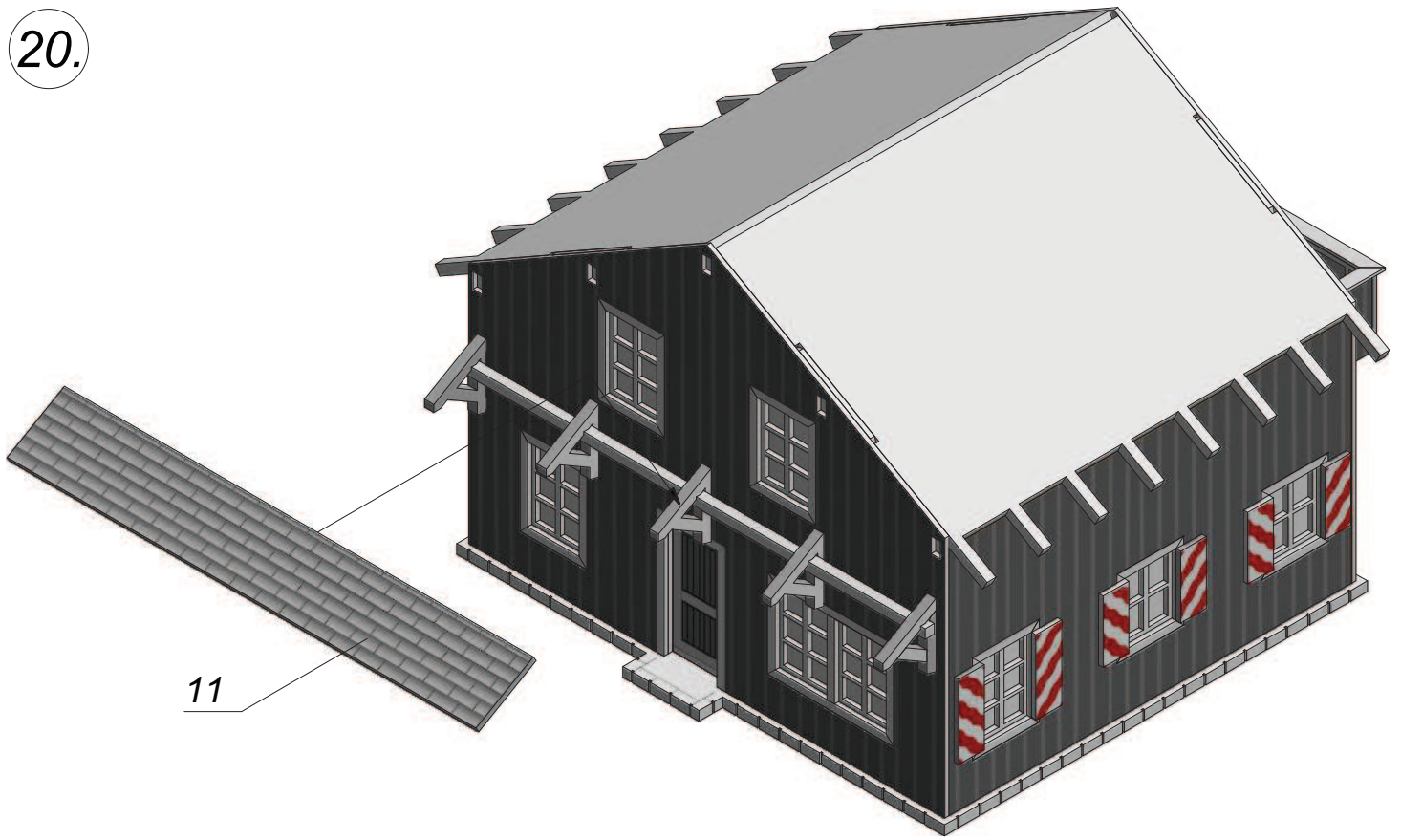

21.

- *Schneiden*

Cut
- *Knicken*

Fold
- *Kleben*

Glue

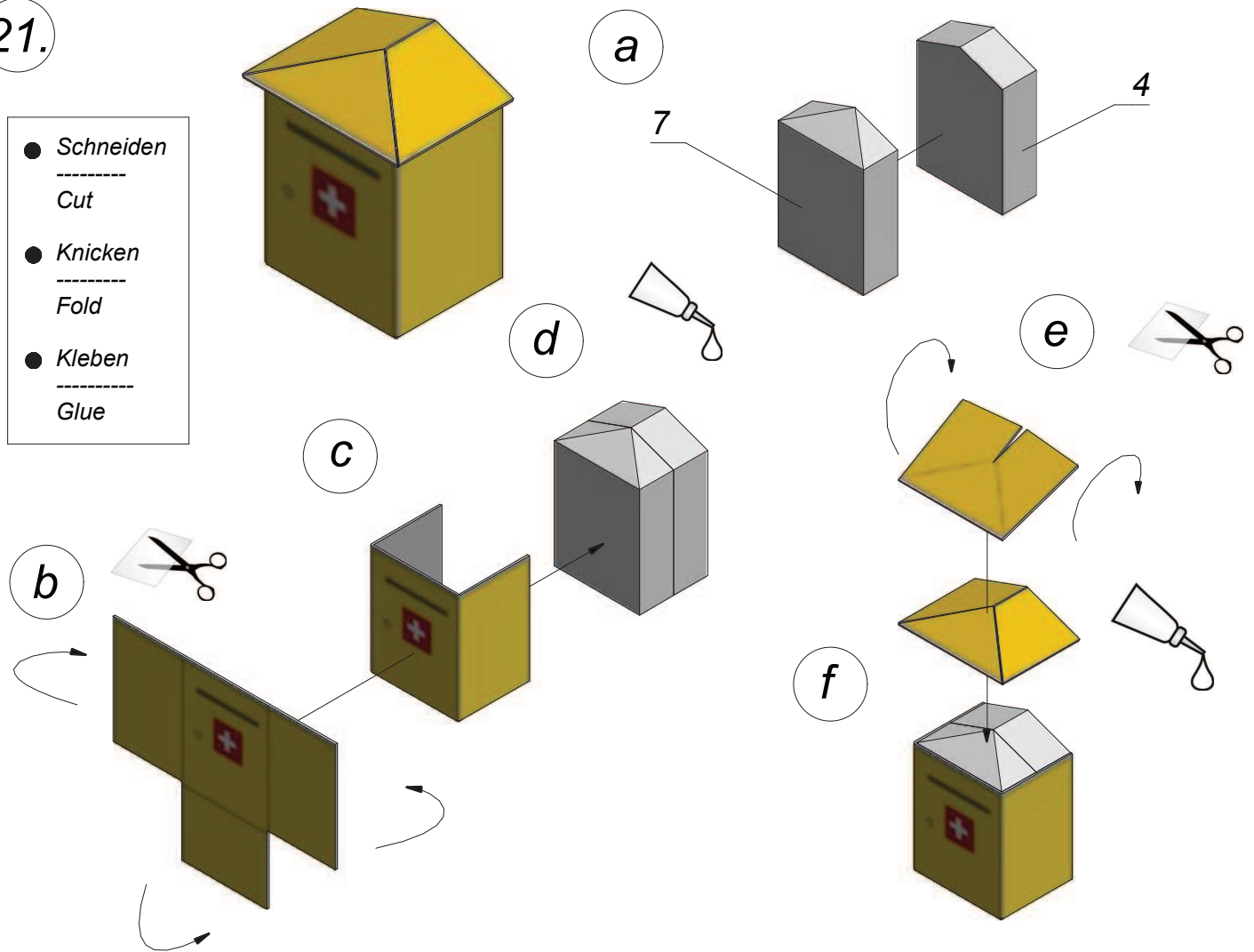

22.

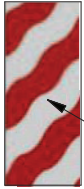

Auf richtige Ausrichtung achten!

Pay attention to correct position!

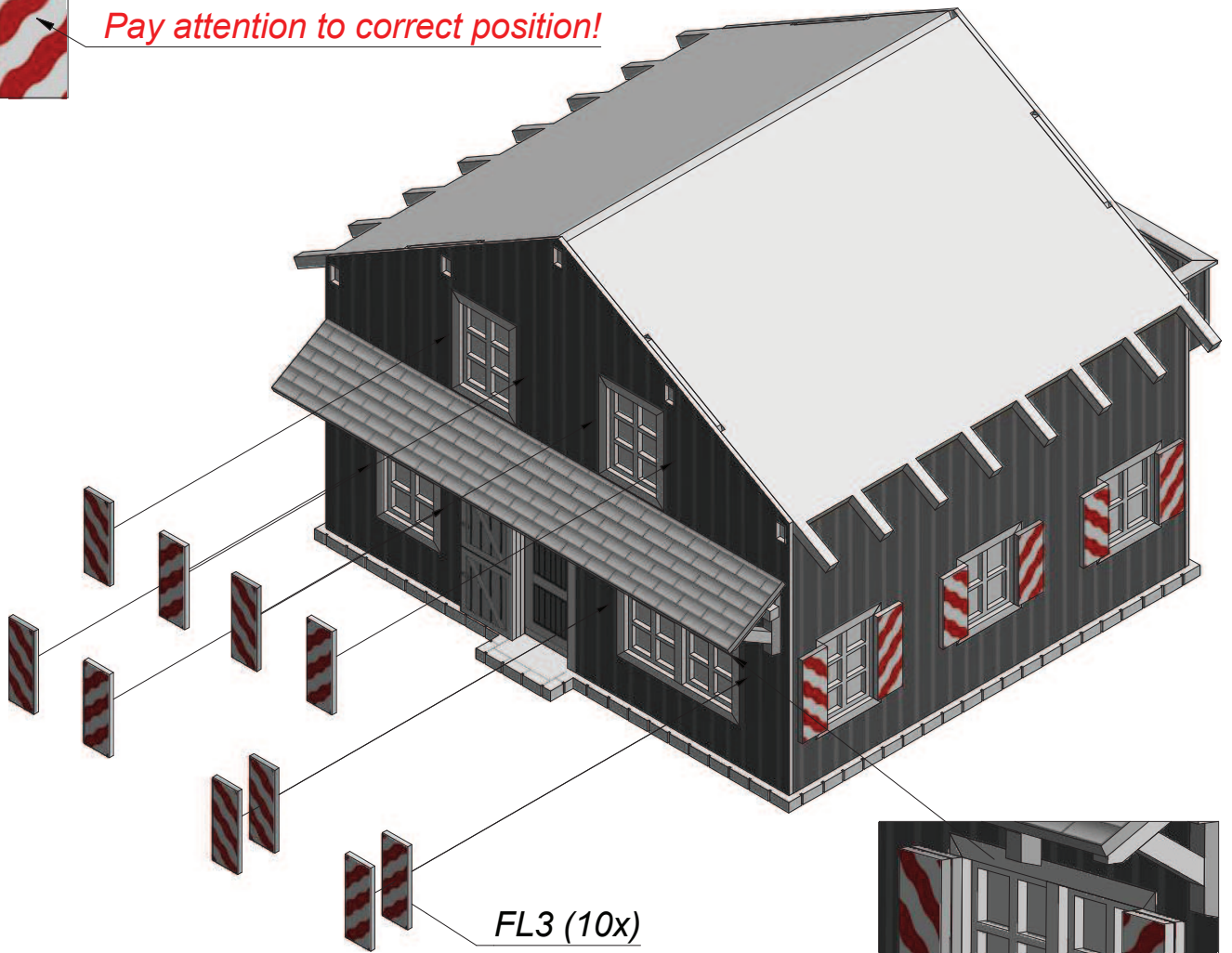

FL3 (10x)

23.

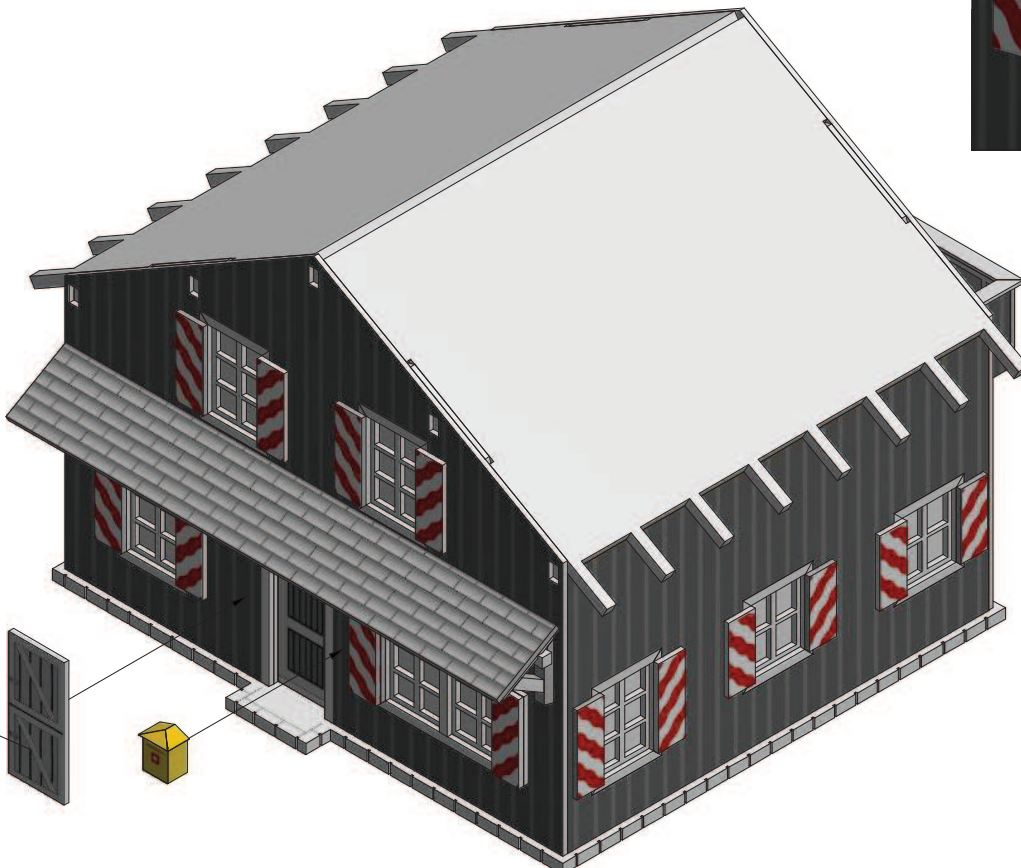

26

24.

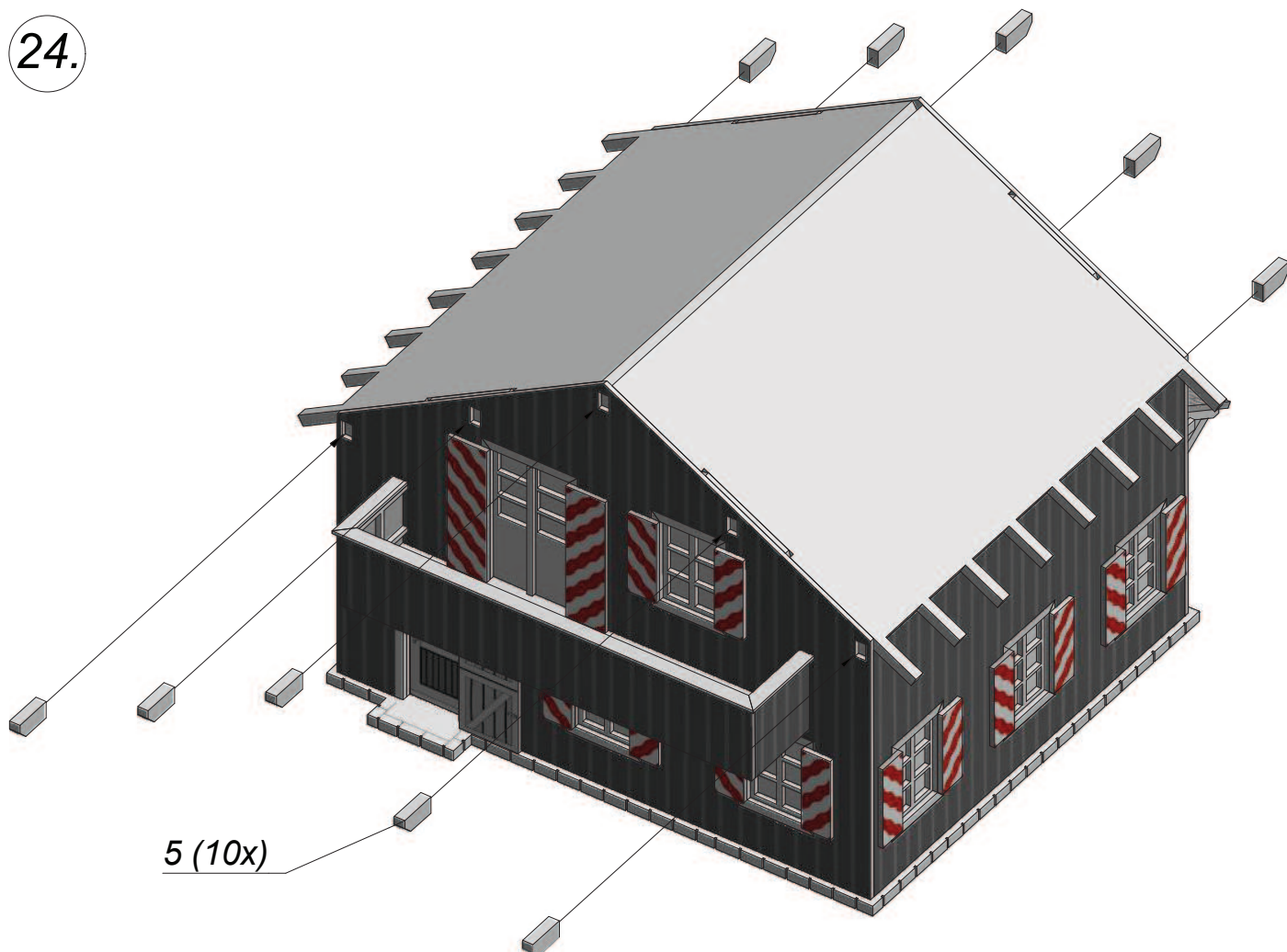

25.

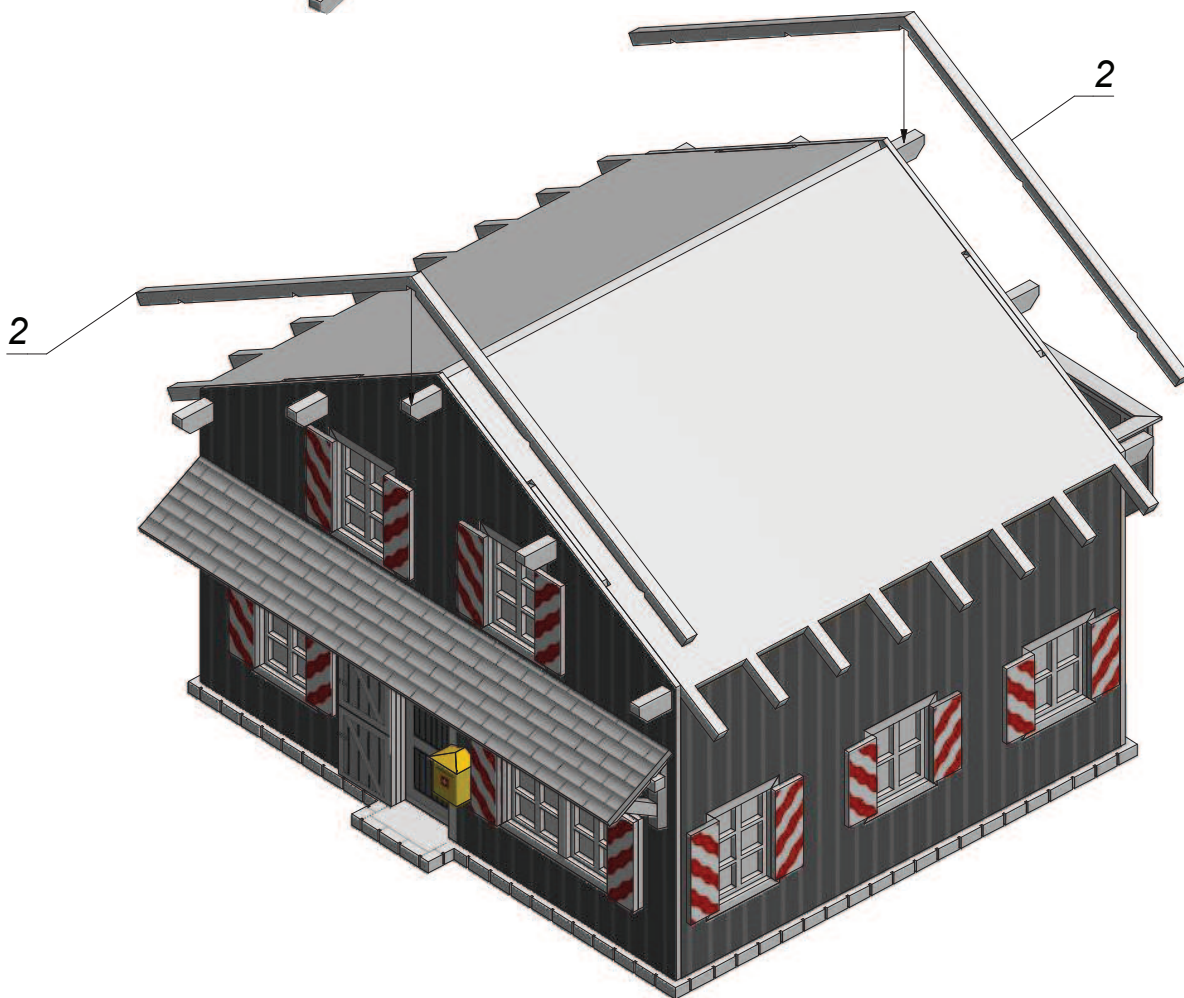

26.

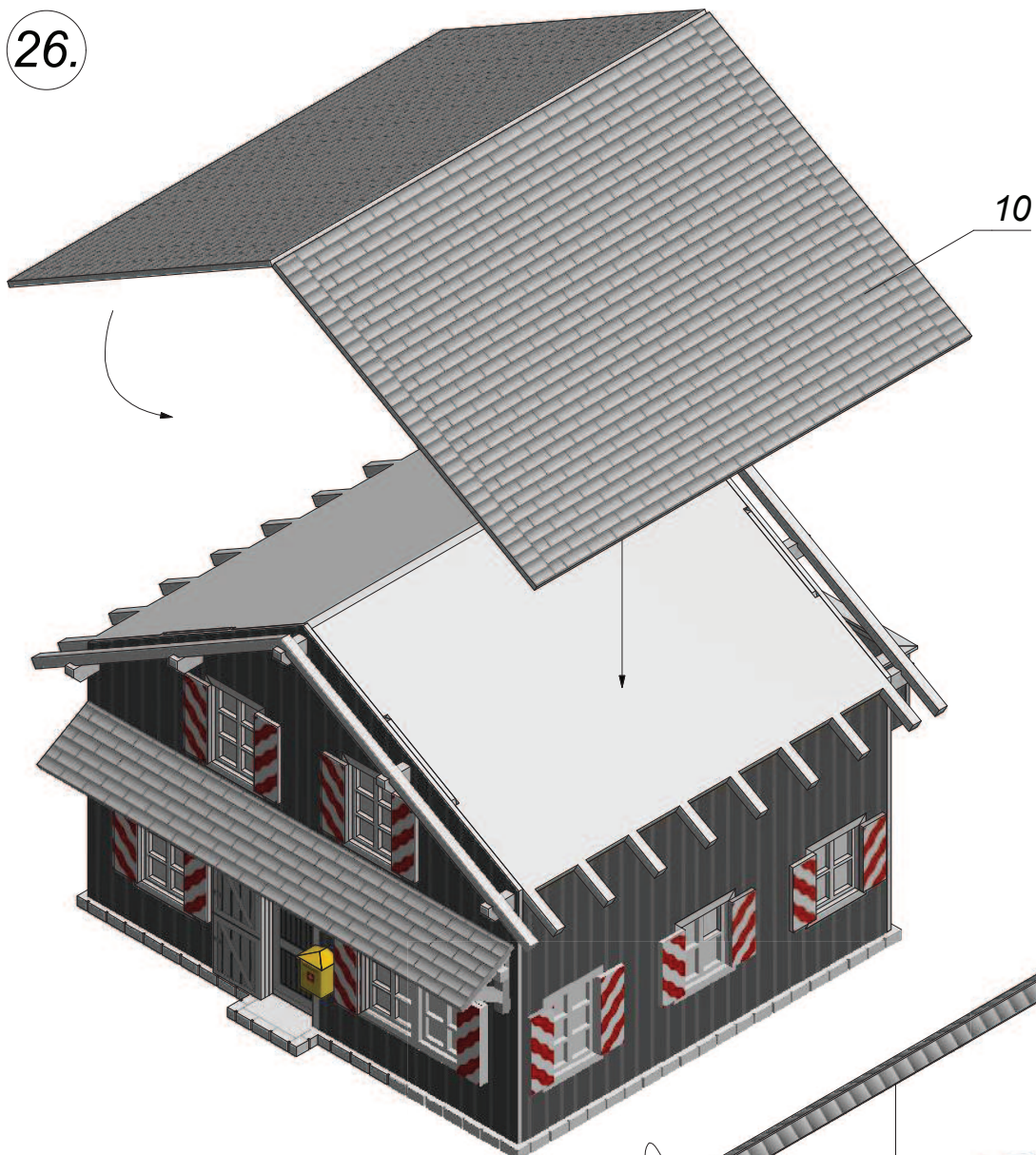

9

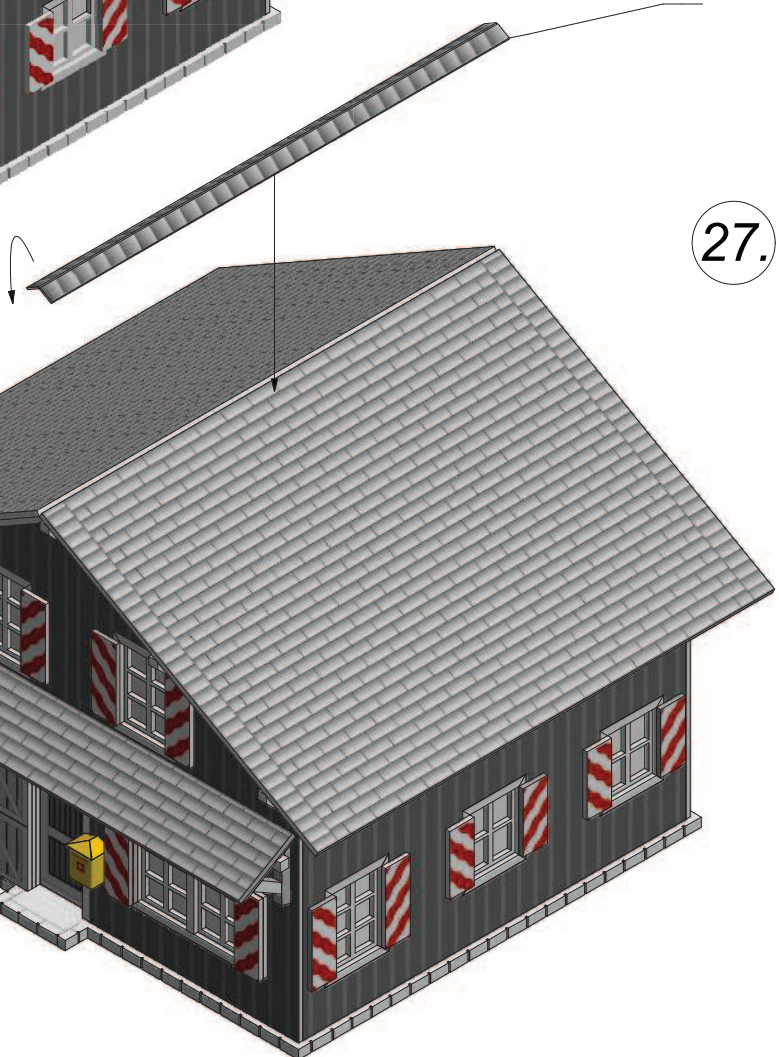

27.

28.

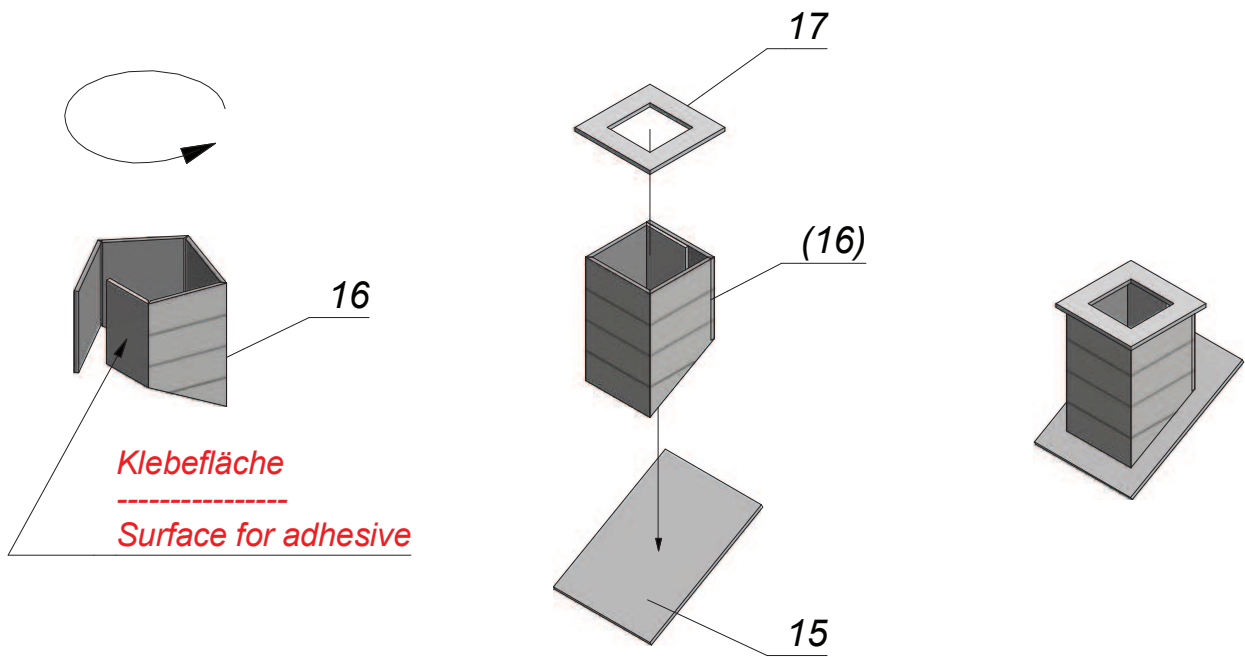

29.

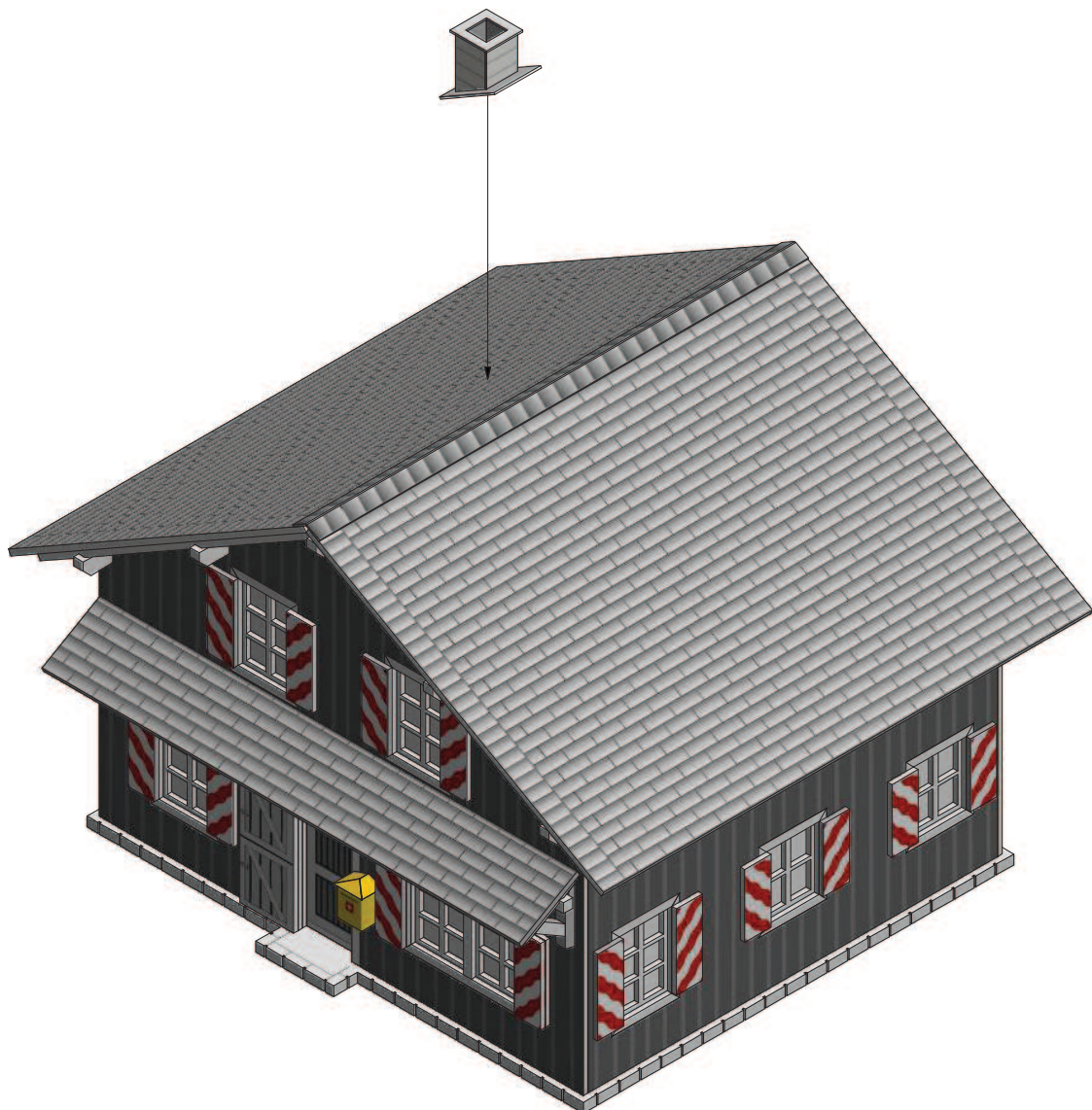

30.

S = Schilder nach Wahl.

Add labels at your choice.

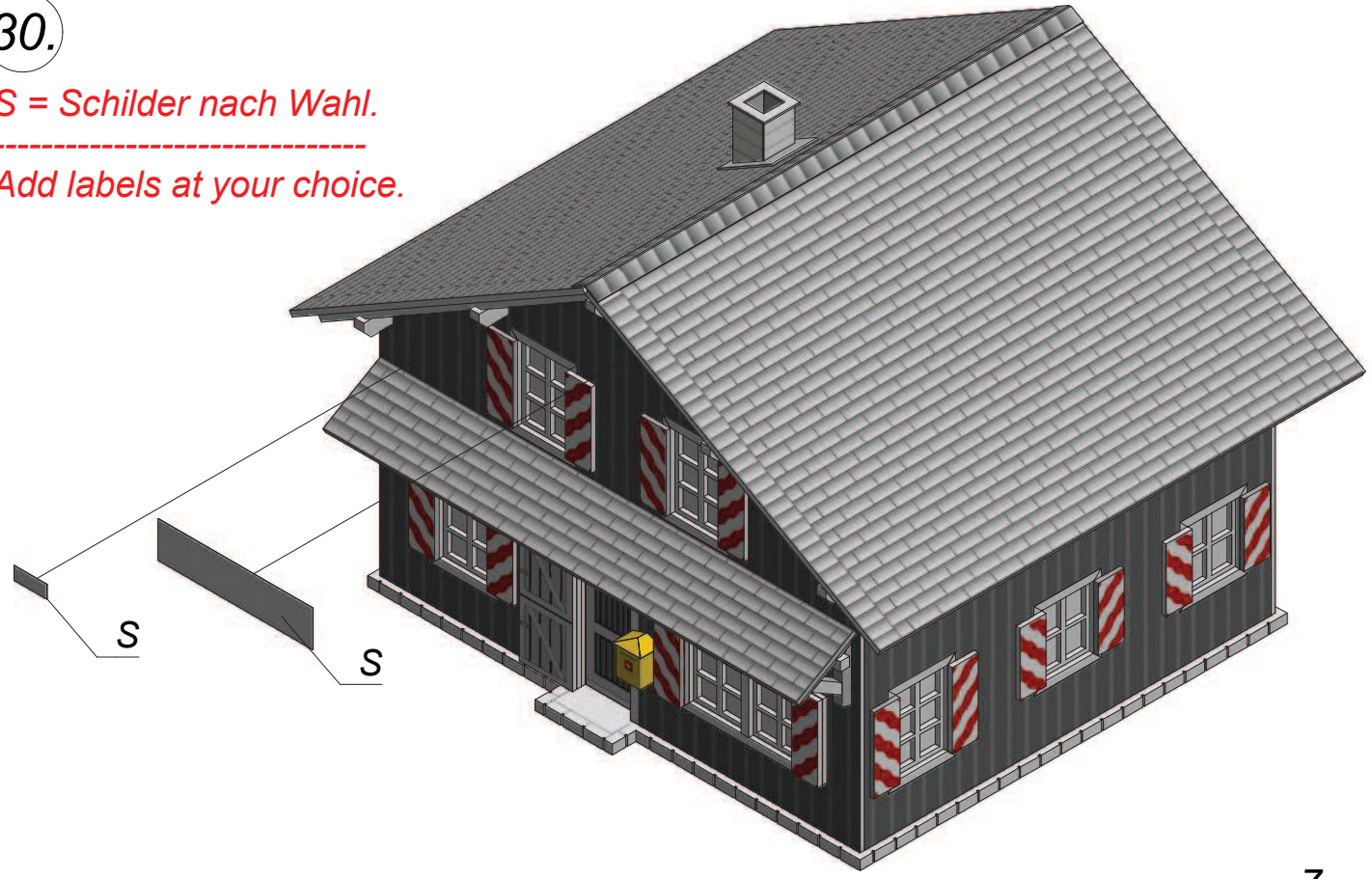

31.

Freie Gestaltungsmöglichkeit mit Deko-Bogen.

Arrange with the deco-sheet at your choice.

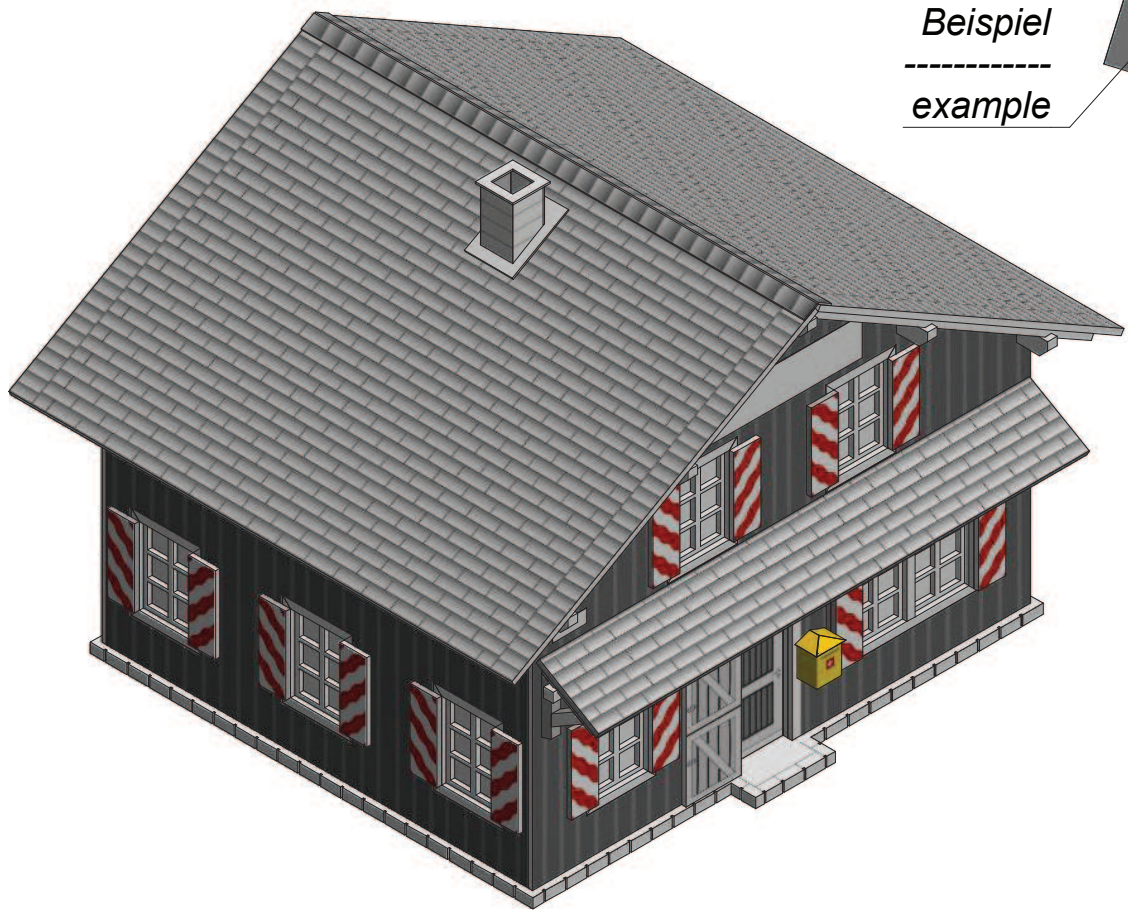

Beispiel

example

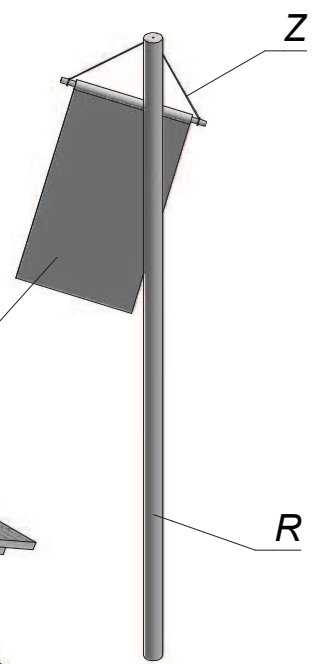

- Schneiden

Cut
- Knicken

Fold
- Kleben

Glue

Dachrinnen-System / Gutter System



Deutsch

Mit dem Dachrinnenbausatz können Sie Dachrinnen und Fallrohre individuell auf Ihr Gebäude anpassen.

Beginnen Sie immer mit dem Anbringen der Dachrinnen am Dach. Kürzen Sie diese mit einem scharfen Messer.

Achten Sie darauf, mindestens einen Regenablauf an einer Seite beizubehalten. Sollten Sie zwei Regenabläufe rechts und links benötigen, schneiden Sie die überschüssige Länge der Dachrinne aus der Mitte heraus und setzen Sie beide Enden anschließend wieder zusammen.

Passen Sie anschließend - wenn notwendig - das Winkelstück an den bestehenden Dachvorsprung an und stecken Sie es von unten in den Ablauf der Dachrinne.

Längen Sie die Fallrohre entsprechend der Höhe des Gebäudes ab.

English

To create individual drain pipes for your model building use the rain drain kit.

Start with the fixation of the roof rails. Shorten them with a sharp cutter. Leave at least one drain outlet at each roof rail.

If you need two outlets (right and left), cut away the middle part of the roof rail and connect both ends afterwards.

Put the angle pieces into the drain outlet from the bottom.

Shorten the water downpipes according to the height of your model building.



... wie im Original

Ebenfalls erhältlich / Also available:



HO 66713 Laser-Cut Bausatz Hofgut »Franz Furhmann & Co.«
Laser-Cut Kit Great Farm »Franz Furhmann & Co.«



HO 66701 Laser-Cut Bausatz micro-motion Liebes-Stadl
Laser-Cut Kit micro-motion Love Barn